

# Gel Electrophoresis

- Used to measure the lengths of DNA fragments.
- When voltage is applied to DNA, different size fragments migrate to different distances (smaller ones travel farther).

# Gel Pictures

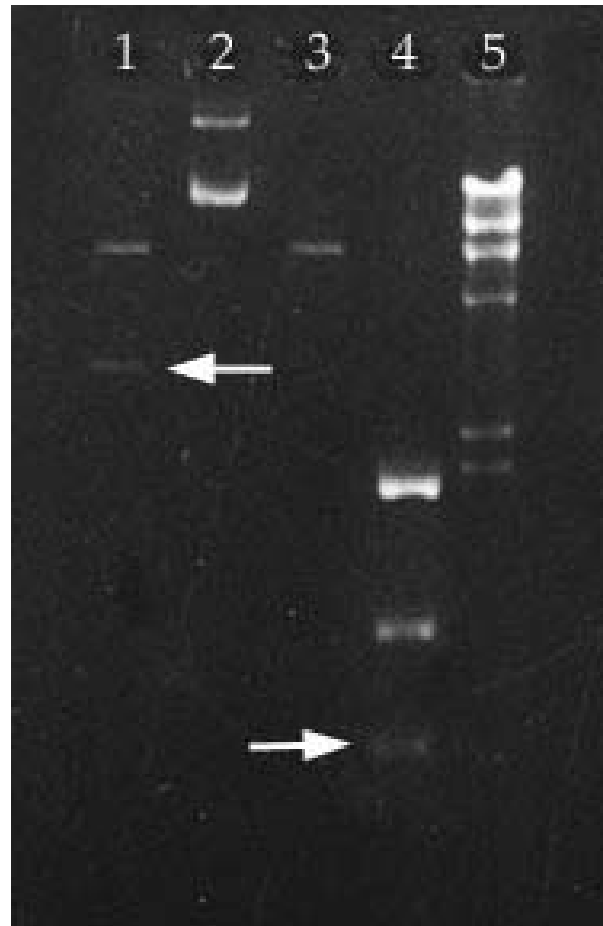

# Gel Electrophoresis: Measure sizes of fragments

- The phosphate backbone makes DNA a highly negatively charged molecule. Thus DNA can be fractionated according to its size.
- **Gel:** allow hot 1 % solution of purified agarose to cool and solidify/polymerize (like Jello).
- DNA sample added to wells at the top of a gel and voltage is applied. Larger fragments migrate through the pores slower.
- Proteins can be separated in much the same way, only acrylamide is used as the crosslinking agent.
- Varying concentration of agarose makes different pore sizes & results.

# Gel Electrophoresis

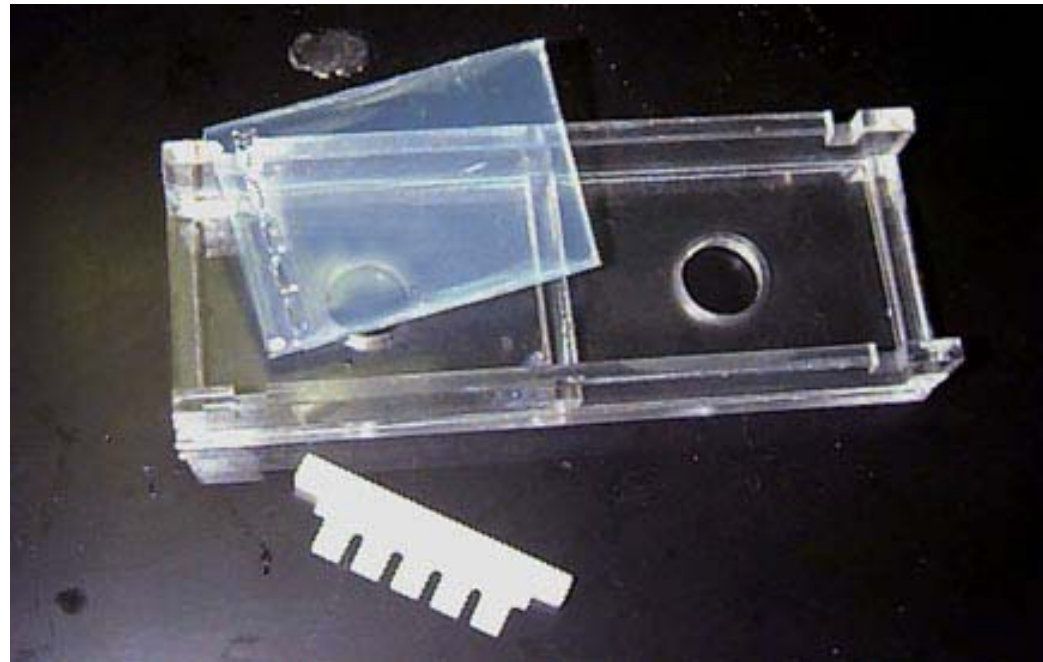

# Gel Electrophoresis

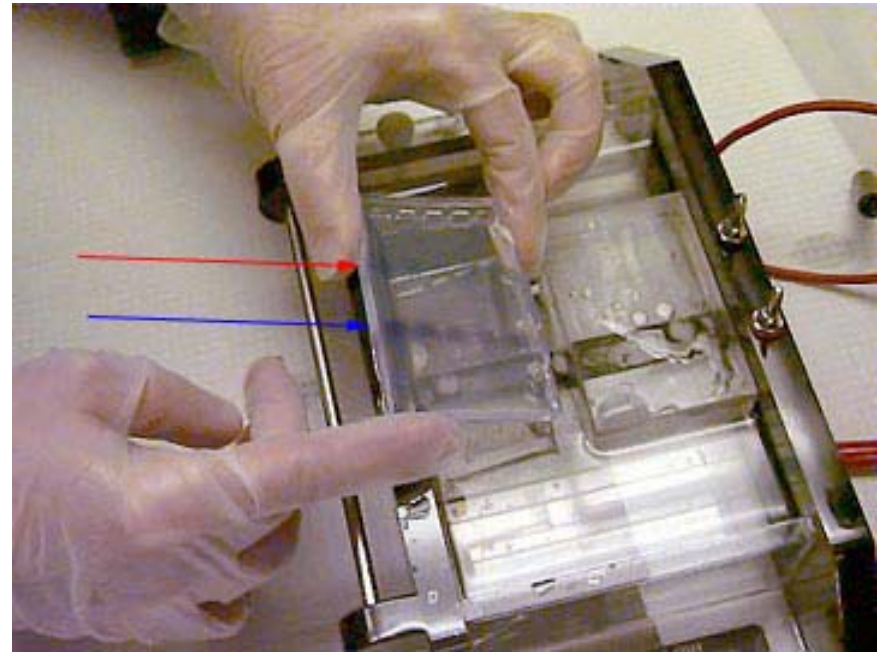
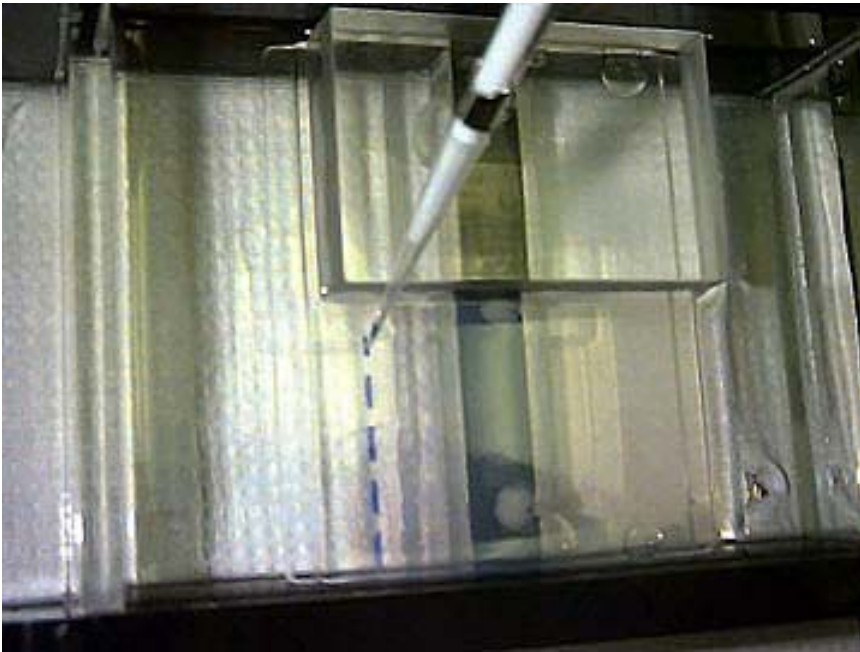

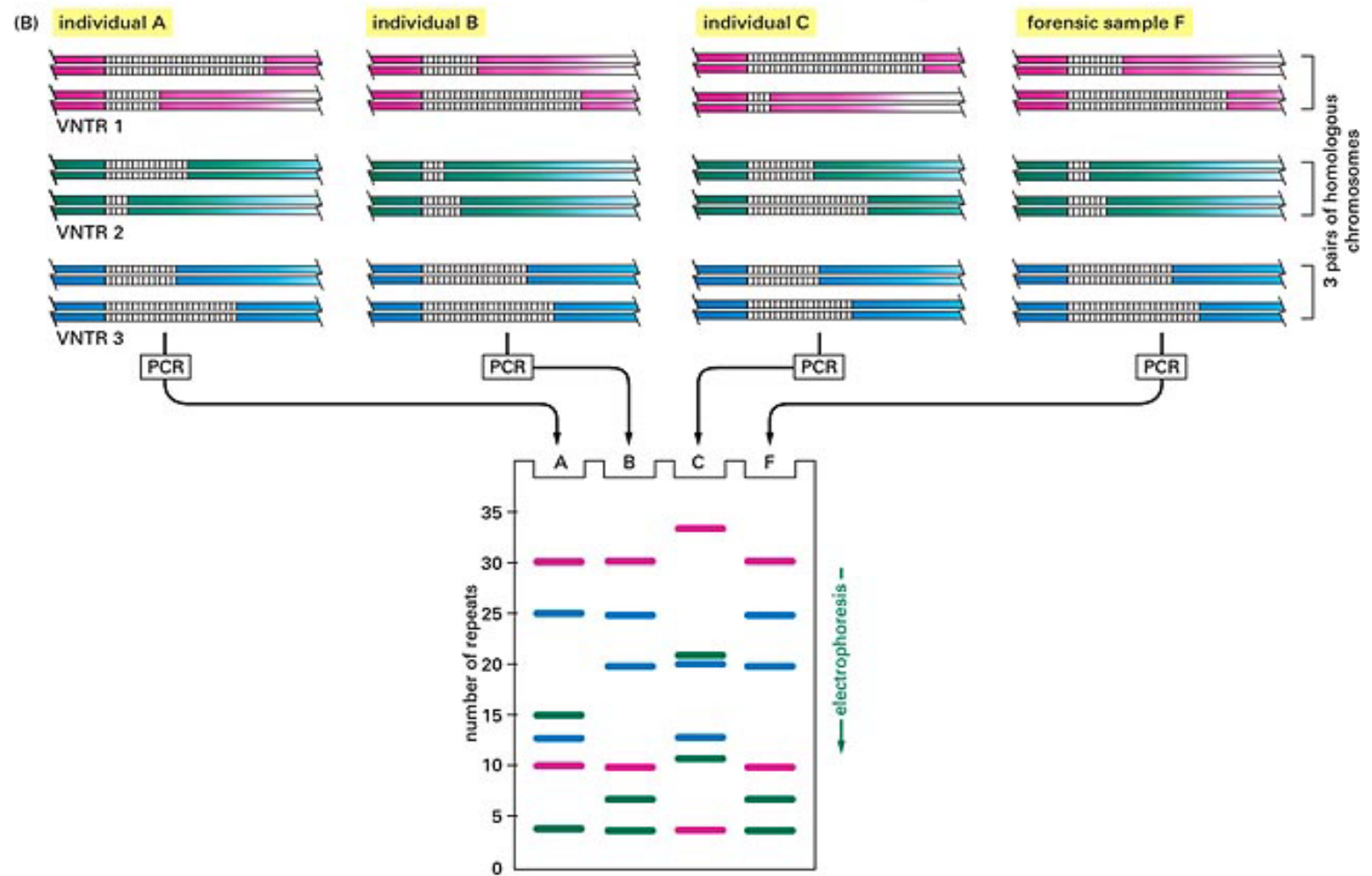
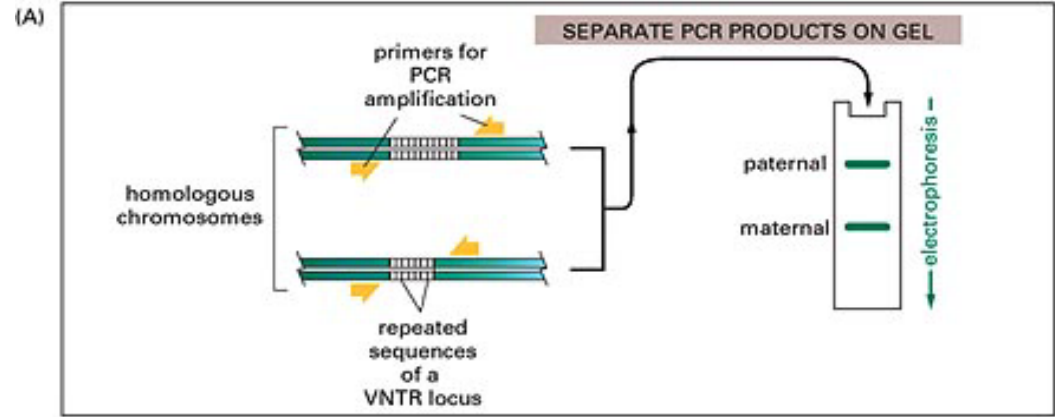

# Sequencing a Fragment Using Gels

- Isolate the desired DNA fragment.
- Using the “**starving method**” obtain all fragments that end in A, C, G, T
- Run gel with 4 lanes and **read** the sequence

# Application of Gels: Sequencing

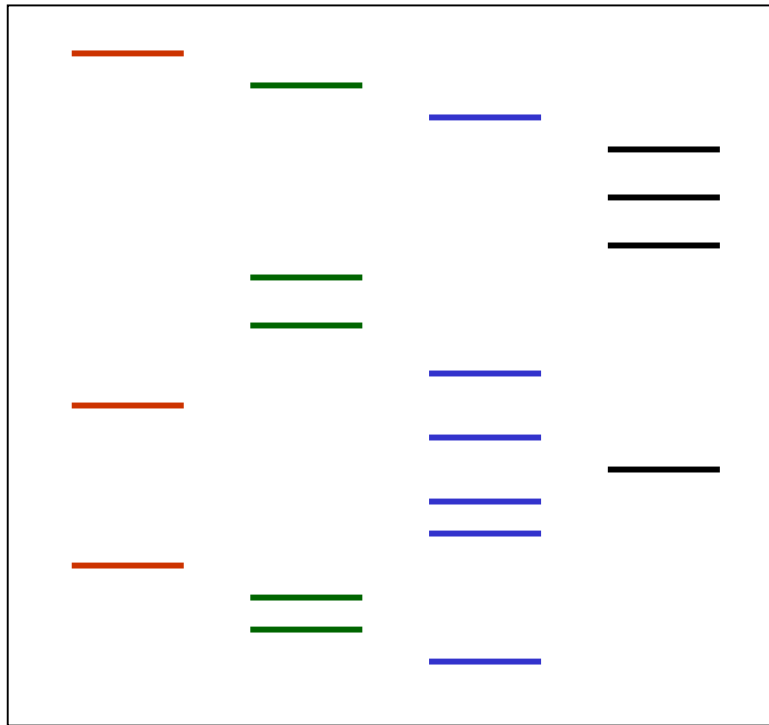

GCCAGGTGAGCCTTTGCA

**A**

**C**

**G**

**T**



# 2D-Gels

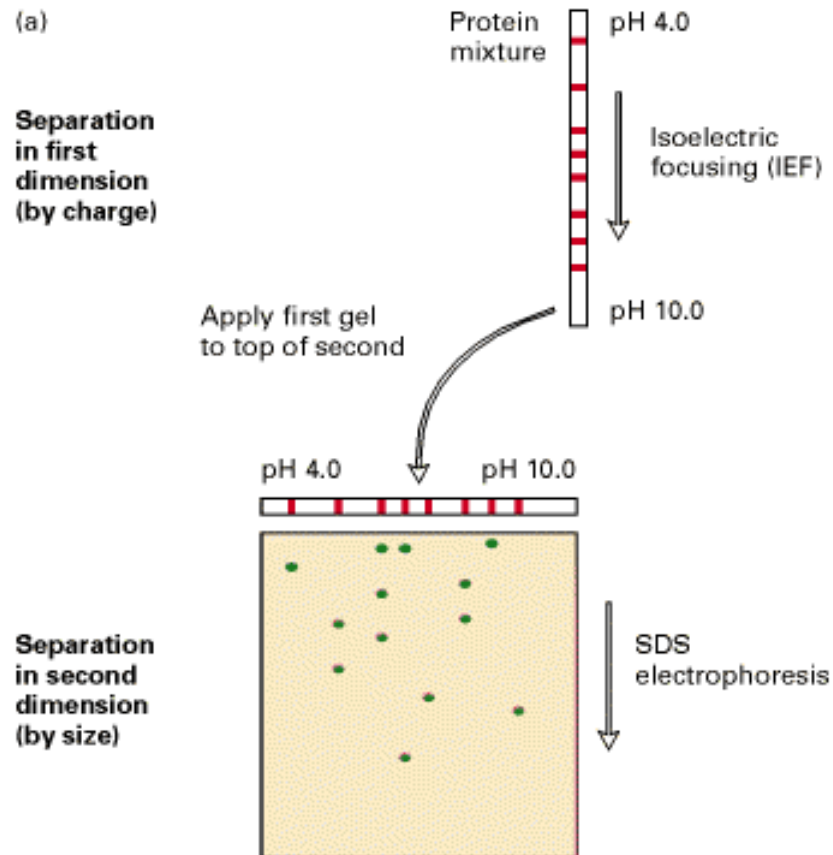

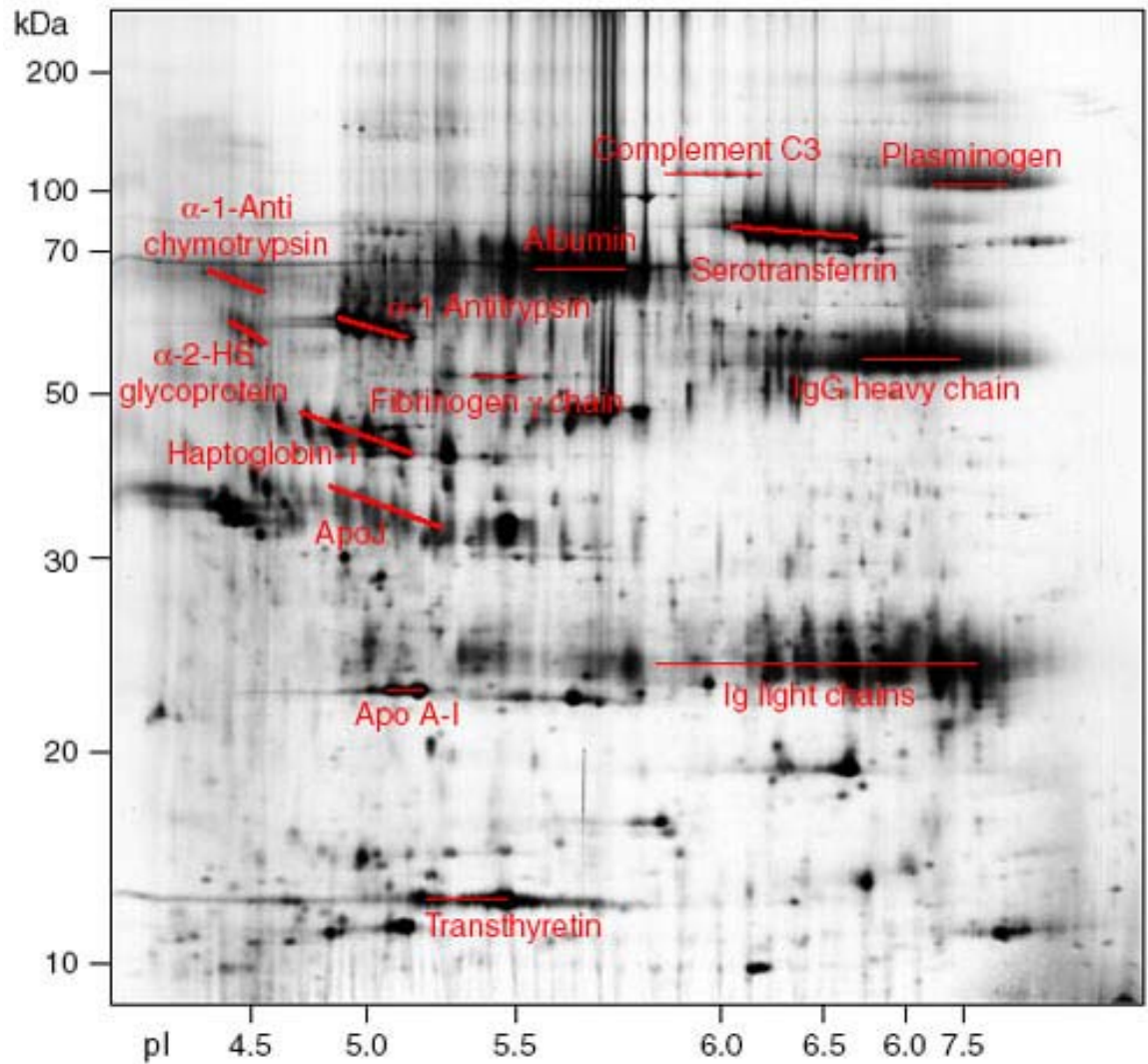

TRENDS in Biotechnology

# 2D-Gels

## **First Dimension Methodology of a 2D Gel:**

Denatured cell extract layered on a glass tube filled with polyacrylamide saturated with solution of ampholytes, a mixture of polyanionic[(-) charged] and polycationic [(+) charged] molecules. When placed in an electric field, the ampholytes separate and form continuous gradient based on net charge. Highly polyanionic ampholytes will collect at one end of tube, highly polycationic ampholytes will collect at other end. Gradient of ampholytes establishes pH gradient. Charged proteins migrate through gradient until they reach their pI, or isoelectric point, the pH at which the net charge of the protein is zero. This resolves proteins that differ by only one charge.

## **Entering the Second Dimension:**

Proteins that were separated on IEF gel are next separated in the second dimension based on their molecular weights. The IEF gel is extruded from tube and placed lengthwise in alignment with second polyacrylamide gel slab saturated with SDS. When an electric field is imposed, the proteins migrate from IEF gel into SDS slab gel and then separate according to mass. Sequential resolution of proteins by their charge and mass can give excellent separation of cellular proteins. As many as 1000 proteins can be resolved simultaneously.

\*Some information was taken from Lodish *et al.* Molecular Cell Biology.

# 2D-gels

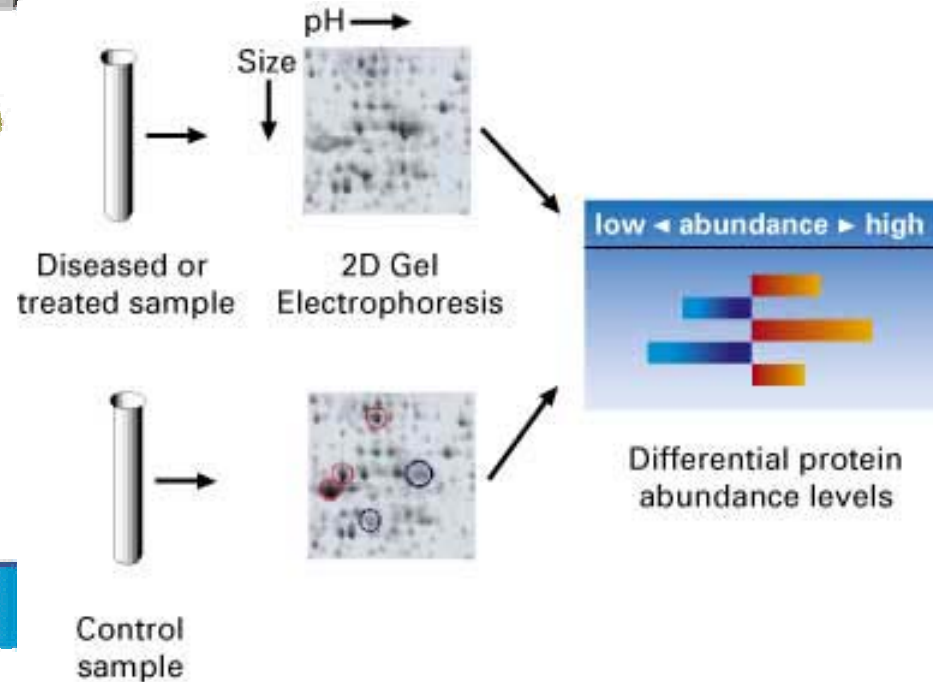
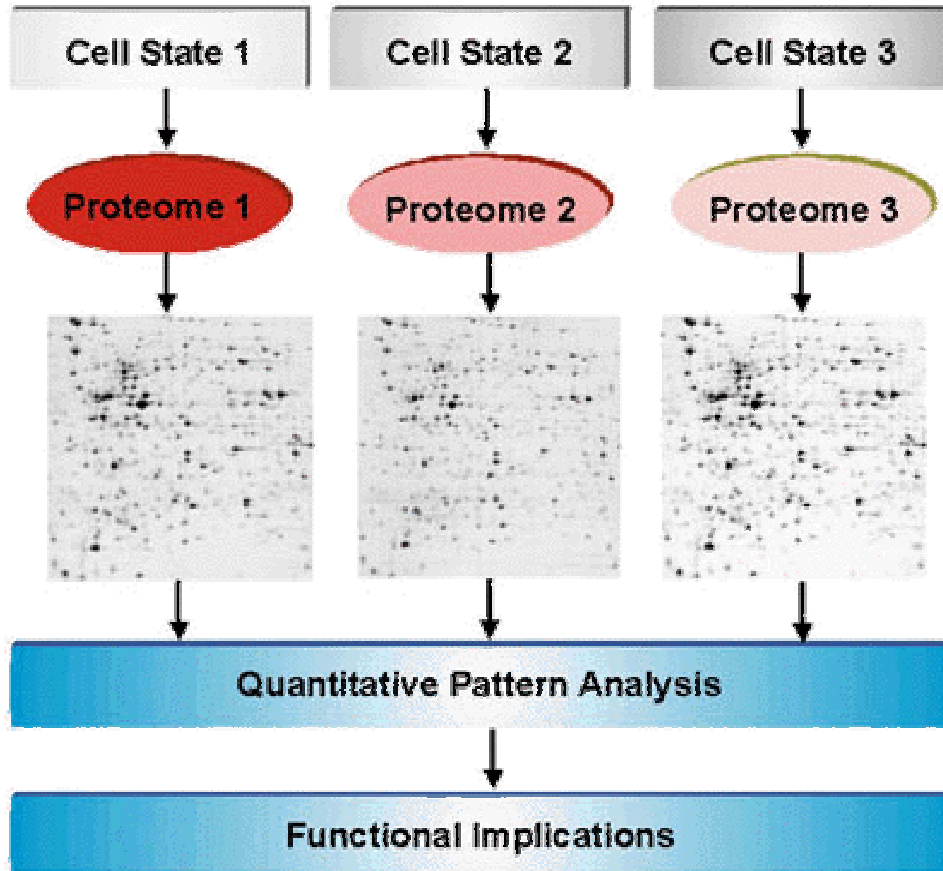

Comparing Proteomes For Differences in Protein Expression

Comparing Different Sample Types For Changes in Protein Levels

# Mass Spectrometry

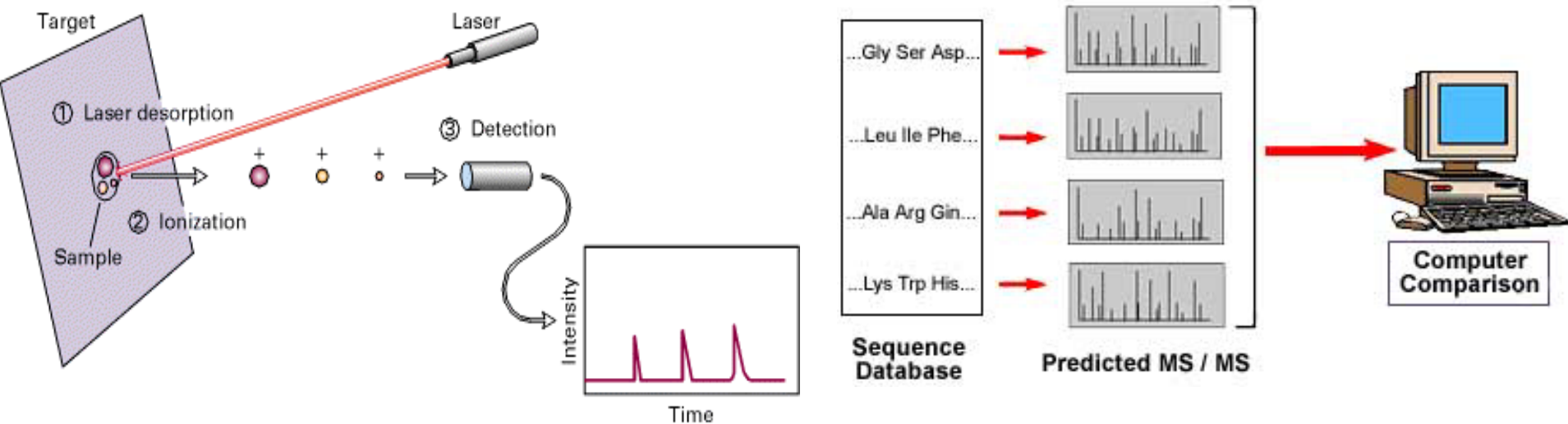

# Mass Spectrometry

- **Mass measurements By Time-of-Flight**

Pulses of light from laser ionizes protein that is absorbed on metal target. Electric field accelerates molecules in sample towards detector. The time to the detector is inversely proportional to the mass of the molecule. Simple conversion to mass gives the molecular weights of proteins and peptides.

- **Using Peptide Masses to Identify Proteins:**

One powerful use of mass spectrometers is to identify a protein from its peptide mass fingerprint. A peptide mass fingerprint is a compilation of the molecular weights of peptides generated by a specific protease. The molecular weights of the parent protein prior to protease treatment and the subsequent proteolytic fragments are used to search genome databases for any similarly sized protein with identical or similar peptide mass maps. The increasing availability of genome sequences combined with this approach has almost eliminated the need to chemically sequence a protein to determine its amino acid sequence.

# Sequencing

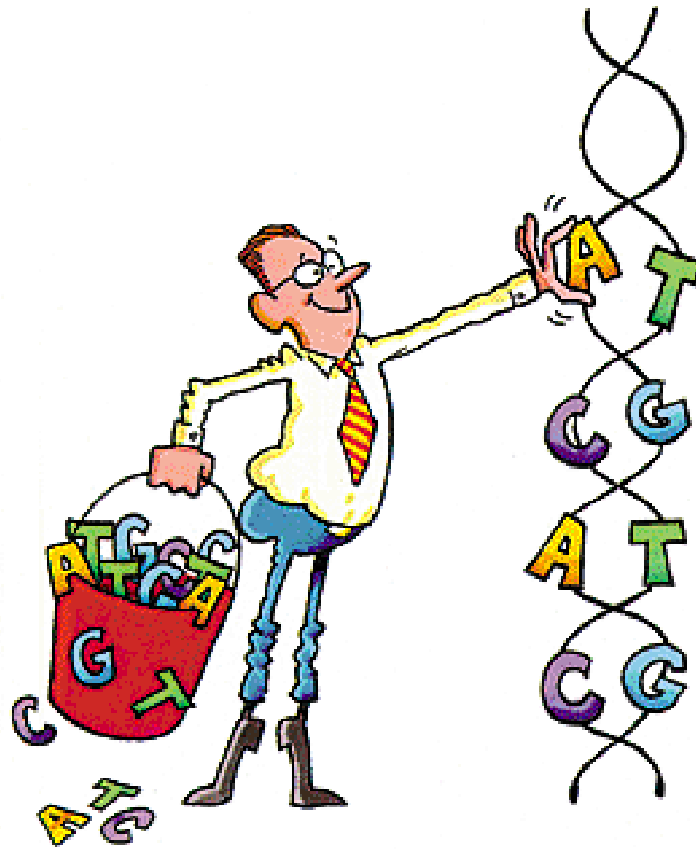

# Shotgun Sequencing

## Hierarchical shotgun sequencing

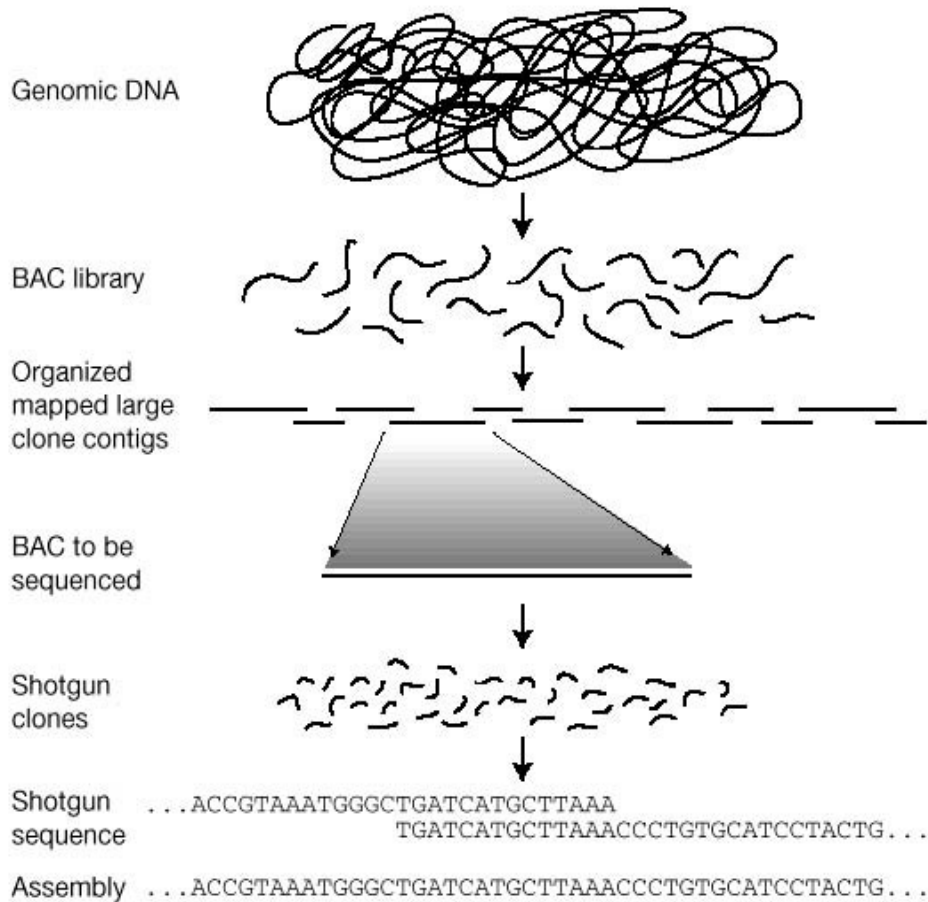

From <http://www.tulane.edu/~biochem/lecture/723/humgen.html>



# Shotgun Sequencing

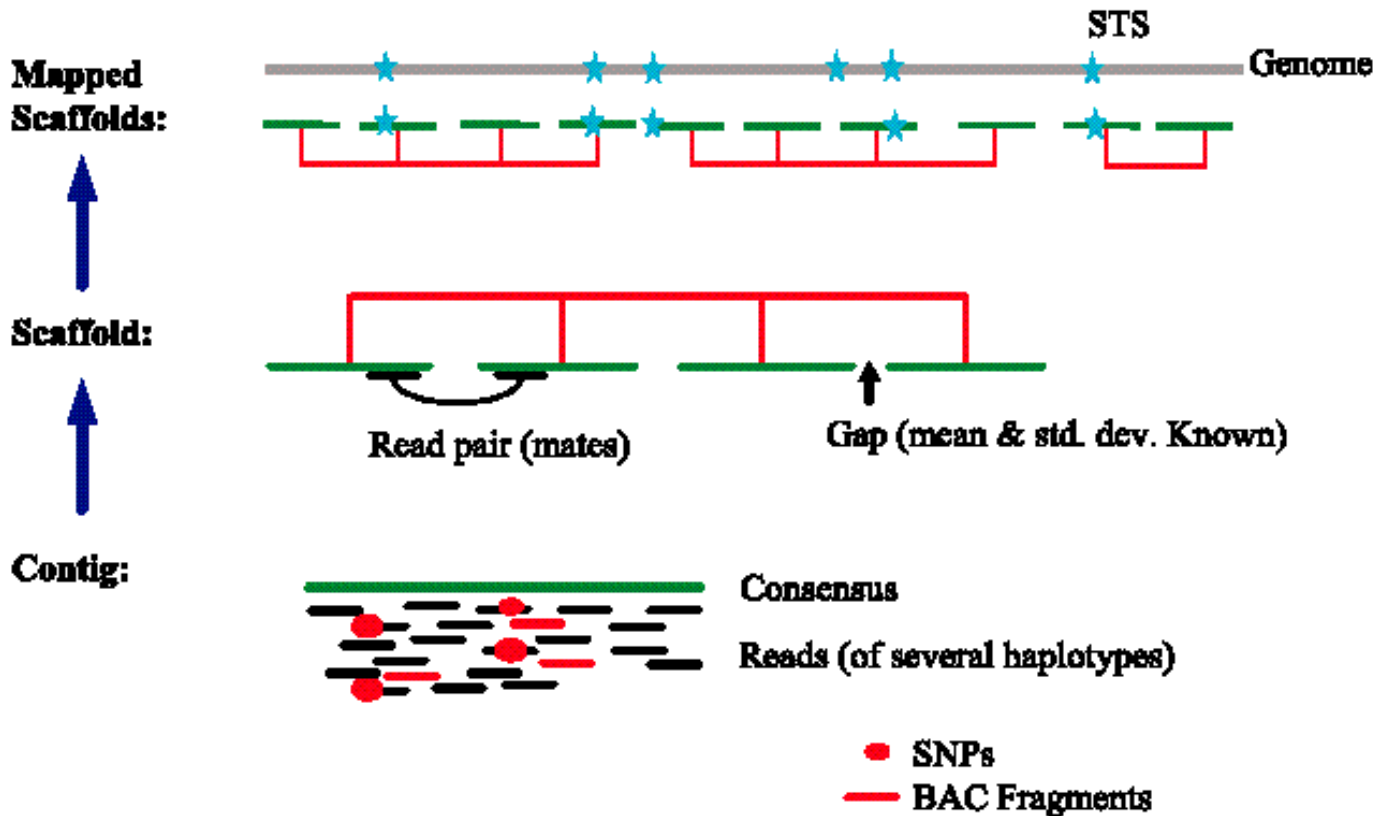

From <http://www.tulane.edu/~biochem/lecture/723/humgen.html>

# Human Genome Project

## **Play the Sequencing Video:**

- Download Windows file from

<http://www.cs.fiu.edu/~giri/teach/6936/Papers/Sequence.exe>

- Then run it on your PC.

# Assembly: Simple Example

- ACCGT, CGTGC, TTAC, TACCGT
- Total length = ~10
- 

» --ACCGT--

» ----CGTGC

» TTAC-----

» -TACCGT-

» **TTACCGTGC**

# Assembly: Complications

- Errors in input sequence fragments (~3%)
  - Indels or substitutions
- Contamination by host DNA
- Chimeric fragments (joining of non-contiguous fragments)
- Unknown orientation
- Repeats (long repeats)
  - Fragment contained in a repeat
  - Repeat copies not exact copies
  - Inherently ambiguous assemblies possible
  - Inverted repeats
- Inadequate Coverage

# Assembly: Complications

$w = \text{AGTATTGGCAATC}$   
 $z = \text{AATCGATG}$   
 $u = \text{ATGCAAACCT}$   
 $x = \text{CCTTTTGG}$   
 $y = \text{TTGGCAATCACT}$

```

AGTATTGGCAATC---AATCGATG-----
-----ATGCAAACCT-----
---TTGGCAATCACT-----CCTTTTGG
-----
AGTATTGGCAATCACTAATCGATGCAAACCTTTTGG
    
```

**FIGURE 4.20**

*A bad solution for an assembly problem, with a multiple alignment whose consensus is a shortest common superstring. This solution has length 36 and is generated by the Greedy algorithm. However, its weakest link is zero.*

```

AGTATTGGCAATC-----CCTTTTGG-----
-----AATCGATG-----TTGGCAATCACT
-----ATGCAAACCT-----
-----
AGTATTGGCAATCGATGCAAACCTTTTGGCAATCACT
    
```

**FIGURE 4.21**

*Solution according to the unique Hamiltonian path. This solution has length 37, but exhibits better linkage. Its weakest link is 3.*

# Assembly: Complications

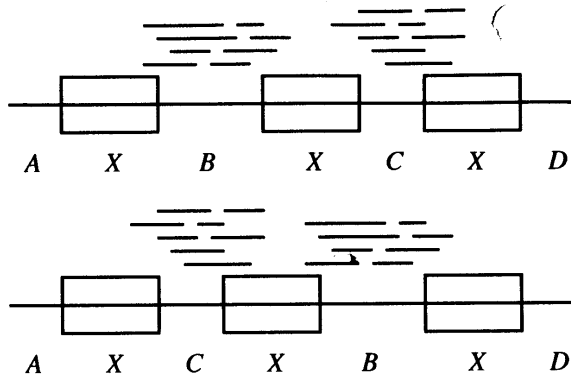

**FIGURE 4.8**

Target sequence leading to ambiguous assembly because of repeats of the form  $XXX$ .

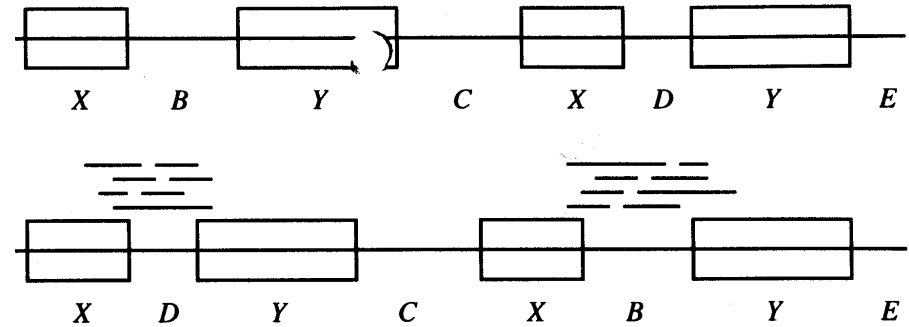

**FIGURE 4.9**

Target sequence leading to ambiguous assembly because of repeats of the form  $XYXY$ .

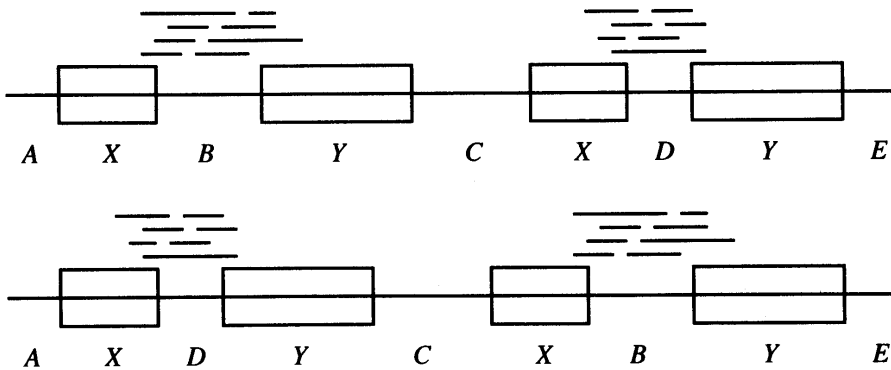

**FIGURE 4.9**

Target sequence leading to ambiguous assembly because of repeats of the form  $XYXY$ .

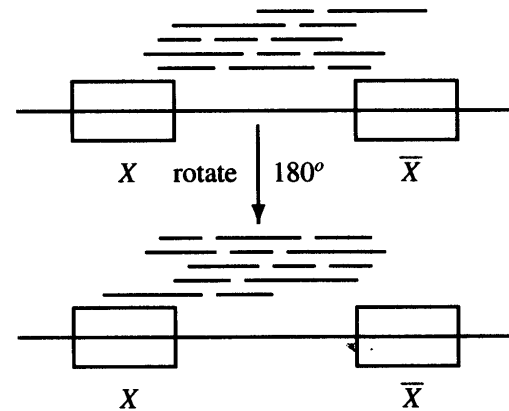

**FIGURE 4.10**

Target sequence with inverted repeat. The region marked  $\bar{X}$  is the reverse complement of the region marked  $X$ .

# Miscellaneous

- **Contig**: A continuously covered region in the assembly.
- Other sequencing methods:
  - Sequencing by Hybridization (**SBH**)
  - Dual end sequencing
  - Chromosome Walking (see page 5-6 of Pevzner's text).

# SBH

- Suppose that the only length 4 fragments that hybridize to S are: **TAGG**, **GGCA**, **CAAA**, **GCAA**, **ATAG**, **AGGC**. Then what is S, if it is of length ~9?

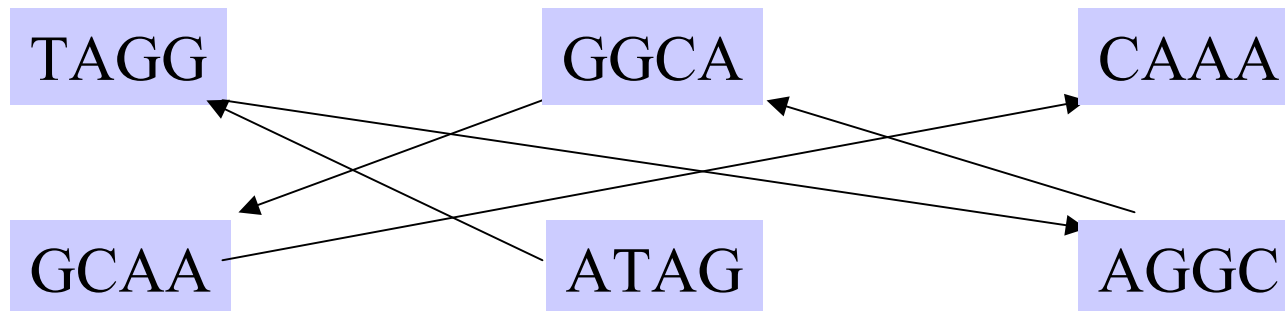

Hamiltonian Path Problem



# SBH

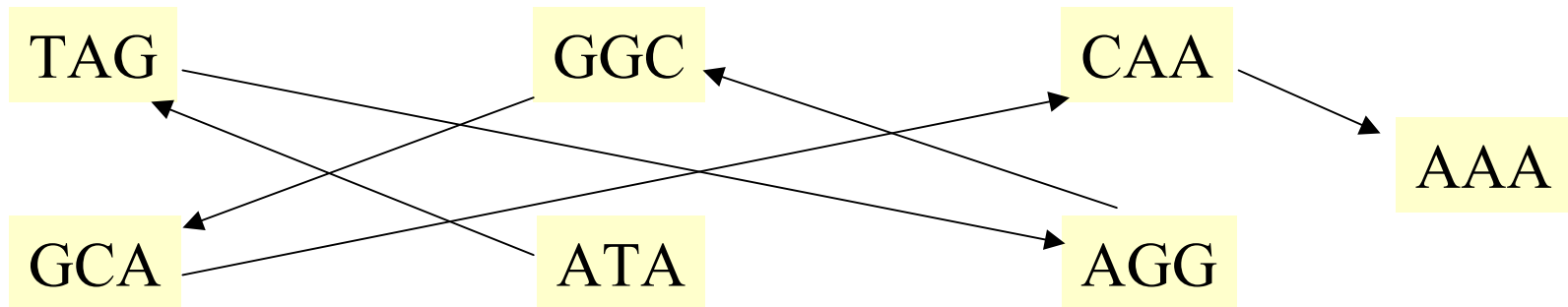

Eulerian Path Problem

# Assembly Software

- Parallel EST alignment engine (<http://corba.ebi.ac.uk/EST>) with a CORBA interface to alignment database. Can perform ad hoc assemblies. Can act as foundation for CORBA-based EST assembly and editing package. [Parsons, EBI]
- Software using multiple alternative sequence assembly "engines" writing to a common format file [Staden, Cambridge] (<http://www.mrc-lmb.cam.ac.uk/pubseq/index.html>).
- Phrap, (<http://bozeman.genome.washington.edu/phrap.docs/phrap.html>)
- Assembler (TIGR) for EST and Microbial whole-genome assembly (<http://www.tigr.org/softlab/>)
- FAK2 and FAKtory (<http://www.cs.arizona.edu/people/gene/>) [Myers]
- GCG (<http://www.gcg.com>)
- Falcon [Gryan, Harvard] fast ([rascal.med.harvard.edu/gryan/falcon/](http://rascal.med.harvard.edu/gryan/falcon/))
- SPACE, SPASS [Lawrence Berkeley Labs] (<http://www-hgc.lbl.gov/inf/space.html>)
- CAP 2 [Huang] (<http://www.tigem.it/ASSEMBLY/capdoc.html>)