

Neural Networks

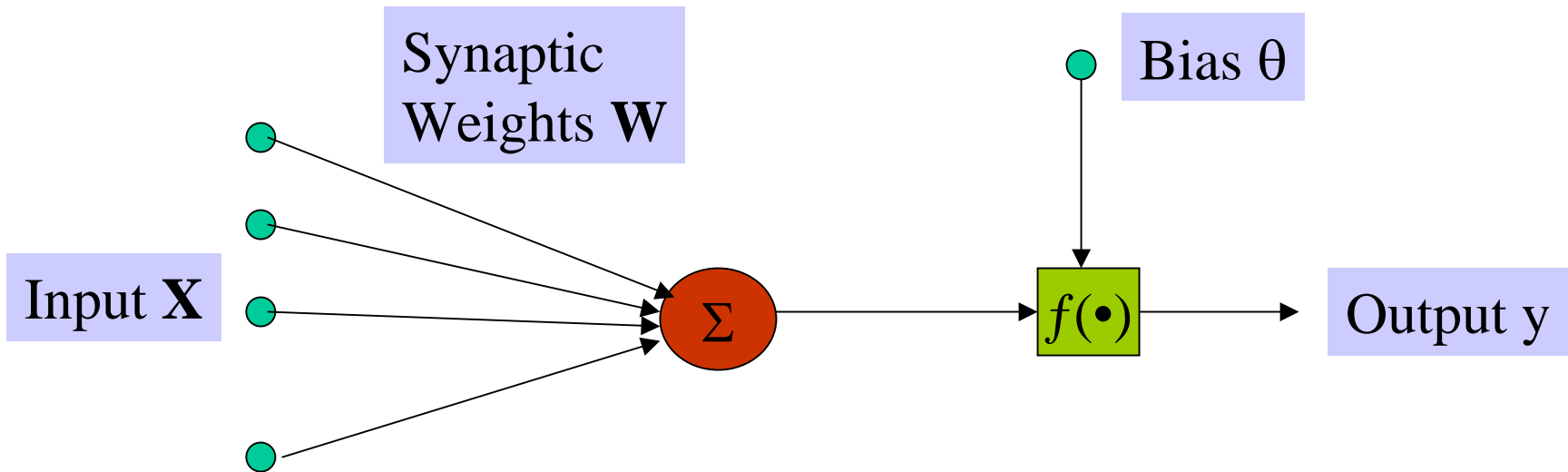

Learning NN

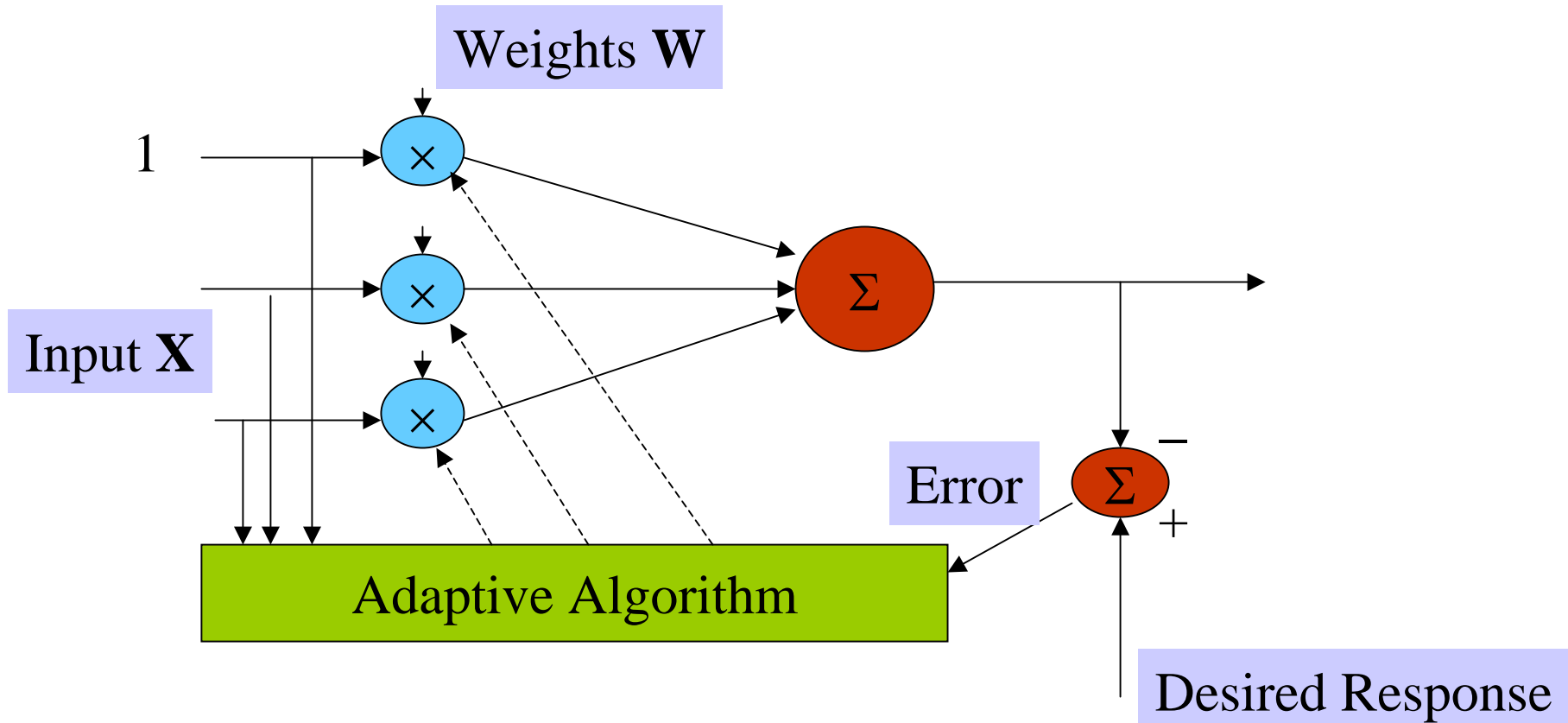

Types of NNs

- Recurrent NN
- Feed-forward NN
- Layered

Other issues

- Hidden layers possible
- Different activation functions possible

Application: Secondary Structure Prediction

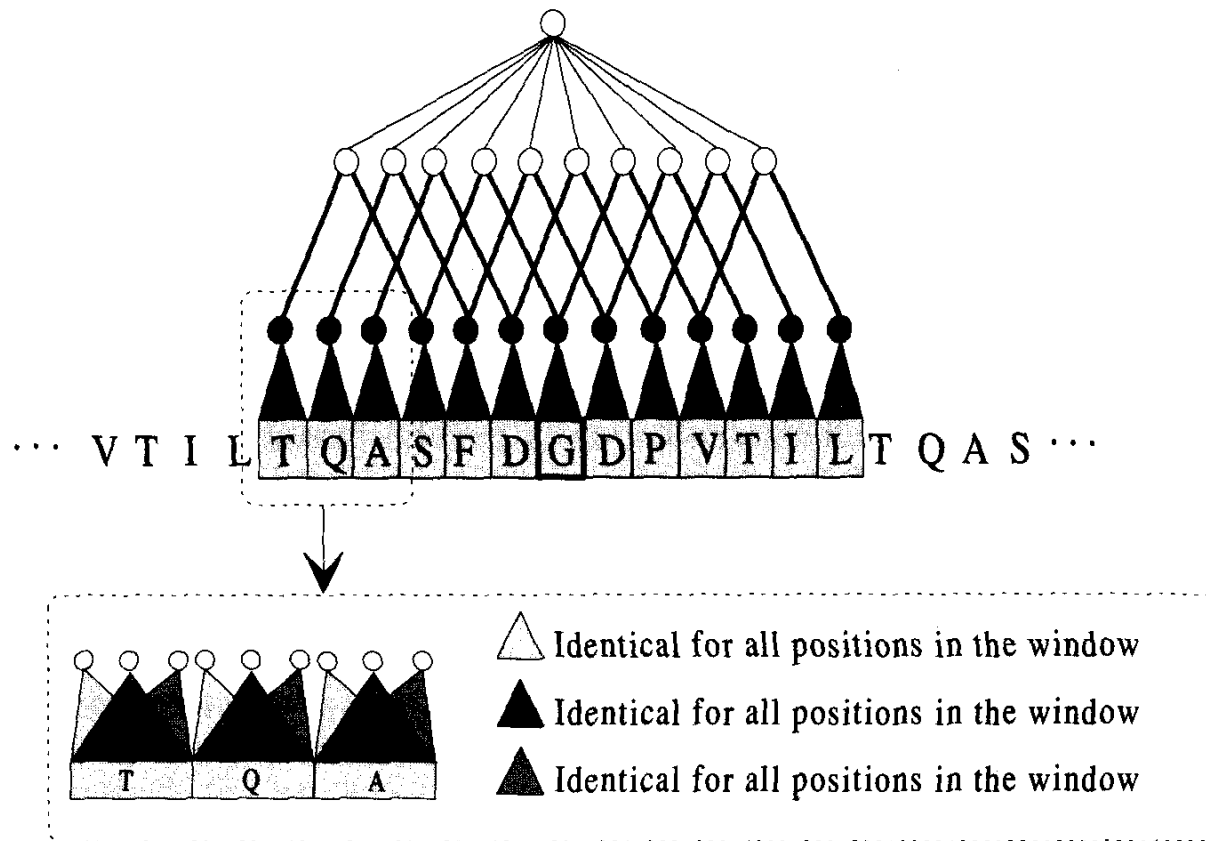

Support Vector Machines

- Supervised Statistical Learning Method for:
 - Classification
 - Regression
- Simplest Version:
 - **Training:** Present series of labeled examples (e.g., gene expressions of tumor vs. normal cells)
 - **Prediction:** Predict labels of new examples.

Learning Problems



SVM – Binary Classification

- Partition feature space with a surface.
- Surface is implied by a subset of the training points (vectors) near it. These vectors are referred to as **Support Vectors**.
- Efficient with high-dimensional data.
- Solid statistical theory
- Subsume several other methods.

Learning Problems

- Binary Classification
- Multi-class classification
- Regression

Class	Method	Learned threshold					Optimized threshold				
		FP	FN	TP	TN	Cost	FP	FN	TP	TN	Cost
Tricarboxylic acid	Radial SVM	8	8	9	2442	24	4	7	10	2446	18
	Dot-product-1 SVM	11	9	8	2439	29	3	6	11	2447	15
	Dot-product-2 SVM	5	10	7	2445	25	4	6	11	2446	16
	Dot-product-3 SVM	4	12	5	2446	28	4	6	11	2446	16
	Parzen	4	12	5	2446	28	0	12	5	2450	24
	FLD	9	10	7	2441	29	7	8	9	2443	23
	C4.5	7	17	0	2443	41	-	-	-	-	-
	MOC1	3	16	1	2446	35	-	-	-	-	-
Respiration	Radial SVM	9	6	24	2428	21	8	4	26	2429	16
	Dot-product-1 SVM	21	10	20	2416	41	6	9	21	2431	24
	Dot-product-2 SVM	7	14	16	2430	35	7	6	24	2430	19
	Dot-product-3 SVM	3	15	15	2434	33	7	6	24	2430	19
	Parzen	22	10	20	2415	42	7	12	18	2430	31
	FLD	10	10	20	2427	30	14	4	26	2423	22
	C4.5	18	17	13	2419	52	-	-	-	-	-
	MOC1	12	26	4	2425	64	-	-	-	-	-
Ribosome	Radial SVM	9	4	117	2337	17	6	1	120	2340	8
	Dot-product-1 SVM	13	6	115	2333	25	11	1	120	2335	13
	Dot-product-2 SVM	7	10	111	2339	27	9	1	120	2337	11
	Dot-product-3 SVM	3	18	103	2343	39	7	1	120	2339	9
	Parzen	6	8	113	2340	22	5	8	113	2341	21
	FLD	15	5	116	2331	25	8	3	118	2338	14
	C4.5	31	21	100	2315	73	-	-	-	-	-
	MOC1	26	26	95	2320	78	-	-	-	-	-

Table 2: Comparison of error rates for various classification methods. Classes are as described in Table 1. The methods are the radial basis function SVM, the SVMs using the scaled dot product kernel raised to the first, second and third power, Parzen windows, Fisher's linear discriminant, and the two decision tree learners, C4.5 and MOC1. The next five columns are the false positive, false negative, true positive and true negative rates summed over three cross-validation splits, followed by the cost, which is the number of false positives plus twice the number of false negatives. These five columns are repeated twice, first using the threshold learned from the training set, and then using the threshold that minimizes the cost on the test set. The threshold optimization is not possible for the decision tree methods, since they do not produce ranked results.

Class	Method	Learned threshold					Optimized threshold				
		FP	FN	TP	TN	Cost	FP	FN	TP	TN	Cost
Proteasome	Radial SVM	3	7	28	2429	17	4	5	30	2428	14
	Dot-product-1 SVM	14	11	24	2418	36	2	7	28	2430	16
	Dot-product-2 SVM	4	13	22	2428	30	4	6	29	2428	16
	Dot-product-3 SVM	3	18	17	2429	39	2	7	28	2430	16
	Parzen	21	5	30	2411	31	3	9	26	2429	21
	FLD	7	12	23	2425	31	12	7	28	2420	26
	C4.5	17	10	25	2415	37	-	-	-	-	-
	MOC1	10	17	18	2422	44	-	-	-	-	-
Histone	Radial SVM	0	2	9	2456	4	0	2	9	2456	4
	Dot-product-1 SVM	0	4	7	2456	8	0	2	9	2456	4
	Dot-product-2 SVM	0	5	6	2456	10	0	2	9	2456	4
	Dot-product-3 SVM	0	8	3	2456	16	0	2	9	2456	4
	Parzen	2	3	8	2454	8	1	3	8	2455	7
	FLD	0	3	8	2456	6	2	1	10	2454	4
	C4.5	2	2	9	2454	6	-	-	-	-	-
	MOC1	2	5	6	2454	12	-	-	-	-	-
Helix-turn-helix	Radial SVM	1	16	0	2450	33	0	16	0	2451	32
	Dot-product-1 SVM	20	16	0	2431	52	0	16	0	2451	32
	Dot-product-2 SVM	4	16	0	2447	36	0	16	0	2451	32
	Dot-product-3 SVM	1	16	0	2450	33	0	16	0	2451	32
	Parzen	14	16	0	2437	46	0	16	0	2451	32
	FLD	14	16	0	2437	46	0	16	0	2451	32
	C4.5	2	16	0	2449	34	-	-	-	-	-
	MOC1	6	16	0	2445	38	-	-	-	-	-

Table 3: Comparison of error rates for various classification methods (continued). See caption for Table 2.

Class	Kernel	Cost for each split					Total
Tricarboxylic acid	Radial	18	21	15	22	21	97
	Dot-product-1	15	22	18	23	22	100
	Dot-product-2	16	22	17	22	22	99
	Dot-product-3	16	22	17	23	22	100
Respiration	Radial	16	18	23	20	16	93
	Dot-product-1	24	24	29	27	23	127
	Dot-product-2	19	19	26	24	23	111
	Dot-product-3	19	19	26	22	21	107
Ribosome	Radial	8	12	15	11	13	59
	Dot-product-1	13	18	14	16	16	77
	Dot-product-2	11	16	14	16	15	72
	Dot-product-3	9	15	11	15	15	65
Proteasome	Radial	14	10	9	11	11	55
	Dot-product-1	16	12	12	17	19	76
	Dot-product-2	16	13	15	17	17	78
	Dot-product-3	16	13	16	16	17	79
Histone	Radial	4	4	4	4	4	20
	Dot-product-1	4	4	4	4	4	20
	Dot-product-2	4	4	4	4	4	20
	Dot-product-3	4	4	4	4	4	20

Table 4: **Comparison of SVM performance using various kernels.** For each of the MYGD classifications, SVMs were trained using four different kernel functions on five different random three-fold splits of the data, training on two-thirds and testing on the remaining third. The first column contains the class, as described in Table 1. The second column contains the kernel function, as described in Table 2. The next five columns contain the threshold-optimized cost (i.e., the number of false positives plus twice the number of false negatives) for each of the five random three-fold splits. The final column is the total cost across all five splits.

Family	Gene	Locus	Error	Description
TCA	YPR001W	CIT3	FN	mitochondrial citrate synthase
	YOR142W	LSC1	FN	α subunit of succinyl-CoA ligase
	YNR001C	CIT1	FN	mitochondrial citrate synthase
	YLR174W	IDP2	FN	isocitrate dehydrogenase
	YIL125W	KGD1	FN	α -ketoglutarate dehydrogenase
	YDR148C	KGD2	FN	component of α -ketoglutarate dehydrogenase complex in mitochondria
	YDL066W	IDP1	FN	mitochondrial form of isocitrate dehydrogenase
Resp	YBL015W	ACH1	FP	acetyl CoA hydrolase
	YPR191W	QCR2	FN	ubiquinol cytochrome-c reductase core protein 2
	YPL271W	ATP15	FN	ATP synthase epsilon subunit
	YPL262W	FUM1	FP	fumarase
	YML120C	NDI1	FP	mitochondrial NADH ubiquinone 6 oxidoreductase
	YKL085W	MDH1	FP	mitochondrial malate dehydrogenase
	YDL067C	COX9	FN	subunit VIIa of cytochrome c oxidase
Ribo	YPL037C	EGD1	FP	β subunit of the nascent-polypeptide-associated complex (NAC)
	YLR406C	RPL31B	FN	ribosomal protein L31B (L34B) (YL28)
	YLR075W	RPL10	FP	ribosomal protein L10
	YAL003W	EFB1	FP	translation elongation factor EF-1 β
Prot	YHR027C	RPN1	FN	subunit of 26S proteasome (PA700 subunit)
	YGR270W	YTA7	FN	member of CDC48/PAS1/SEC18 family of ATPases
	YGR048W	UFD1	FP	ubiquitin fusion degradation protein
	YDR069C	DOA4	FN	ubiquitin isopeptidase
	YDL020C	RPN4	FN	involved in ubiquitin degradation pathway
Hist	YOL012C	HTA3	FN	histone-related protein
	YKL049C	CSE4	FN	required for proper kinetochore function

Table 6: **Consistently misclassified genes.** The table lists all 25 genes that are consistently misclassified by SVMs trained using the MYGD classifications listed in Table 1. Two types of errors are included: a false positive (FP) occurs when the SVM includes the gene in the given class but the MYGD classification does not; a false negative (FN) occurs when the SVM does not include the gene in the given class but the MYGD classification does.

Kernel	DF	Feature	FP	FN	TP	TN
dot-product 0		25	5	4	10	12
dot-product 2		25	5	2	12	12
dot-product 5		25	4	2	12	13
dot-product 10		25	4	2	12	13
dot-product 0		50	4	2	12	13
dot-product 2		50	3	2	12	14
dot-product 5		50	3	2	12	14
dot-product 10		50	3	2	12	14
dot-product 0		100	4	3	11	13
dot-product 2		100	5	3	11	12
dot-product 5		100	5	3	11	12
dot-product 10		100	5	3	11	12
dot-product 0		500	5	3	11	12
dot-product 2		500	4	3	11	13
dot-product 5		500	4	3	11	13
dot-product 10		500	4	3	11	13
dot-product 0		1000	7	3	11	10
dot-product 2		1000	5	3	11	12
dot-product 5		1000	5	3	11	12
dot-product 10		1000	5	3	11	12
dot-product 0		97802	17	0	14	0
dot-product 2		97802	9	2	12	8
dot-product 5		97802	7	3	11	10
dot-product 10		97802	5	3	11	12

Table 1: Error rates for ovarian cancer tissue experiments.

For each setting of the SVM consisting of a kernel and diagonal factor (DF), each tissue was classified. Column 2 is the number of features (clones) used. Reported are the number of normal tissues misclassified (FP), tumor tissues misclassified (FN), tumor tissues classified correctly (TP), and normal tissues classified correctly (TN).

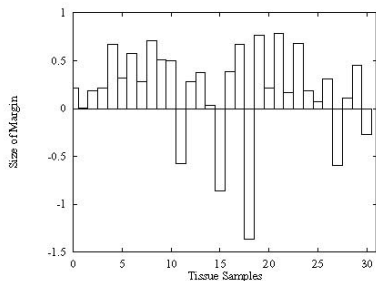

Figure 1: SVM classification margins for ovarian tissues. When classifying, the SVM calculates a margin which is the distance of an example from the decision boundary it has learned. In this graph, the margin for each tissue sample calculated using (10) is shown. A positive value indicates a correct classification, and a negative value indicates an incorrect classification. The most negative point corresponds to tissue N039. The second most negative point corresponds to tissue HWBC3.

Dataset	Features	FP	FN	SVM FP	SVM FN
Ovarian(original)	97802	4.6	4.8	5	3
Ovarian(modified)	97802	4.4	3.4	0	0
AML/ALL train	7129	0.6	2.8	0	0
AML treatment	7129	4.8	3.5	3	2
Colon	2000	3.8	3.7	3	3

Table 5: Results for the perceptron on all data sets. The results are averaged over 5 shufflings of the data as this algorithm is sensitive to the order in which it receives the data points. The first column is the dataset used and the second is number of features in the dataset. For the ovarian and colon datasets, the number of normal tissues misclassified (FP) and the number of tumor tissues misclassified (FN) is reported. For the AML/ALL training dataset, the number of AML samples misclassified (FP) and the number of ALL patients misclassified (FN) is reported. For the AML treatment dataset, the number of unsuccessfully treated patients misclassified (FP) and the number of successfully treated patients misclassified (FN) is reported. The last two columns report the best score obtained by the SVM on that dataset.

SVM – General Principles

- SVMs perform binary classification by partitioning the feature space with a surface implied by a subset of the training points (vectors) near the separating surface. These vectors are referred to as **Support Vectors**.
- Efficient with high-dimensional data.
- Solid statistical theory
- Subsume several other methods.

SVM Example (Radial Basis Function)

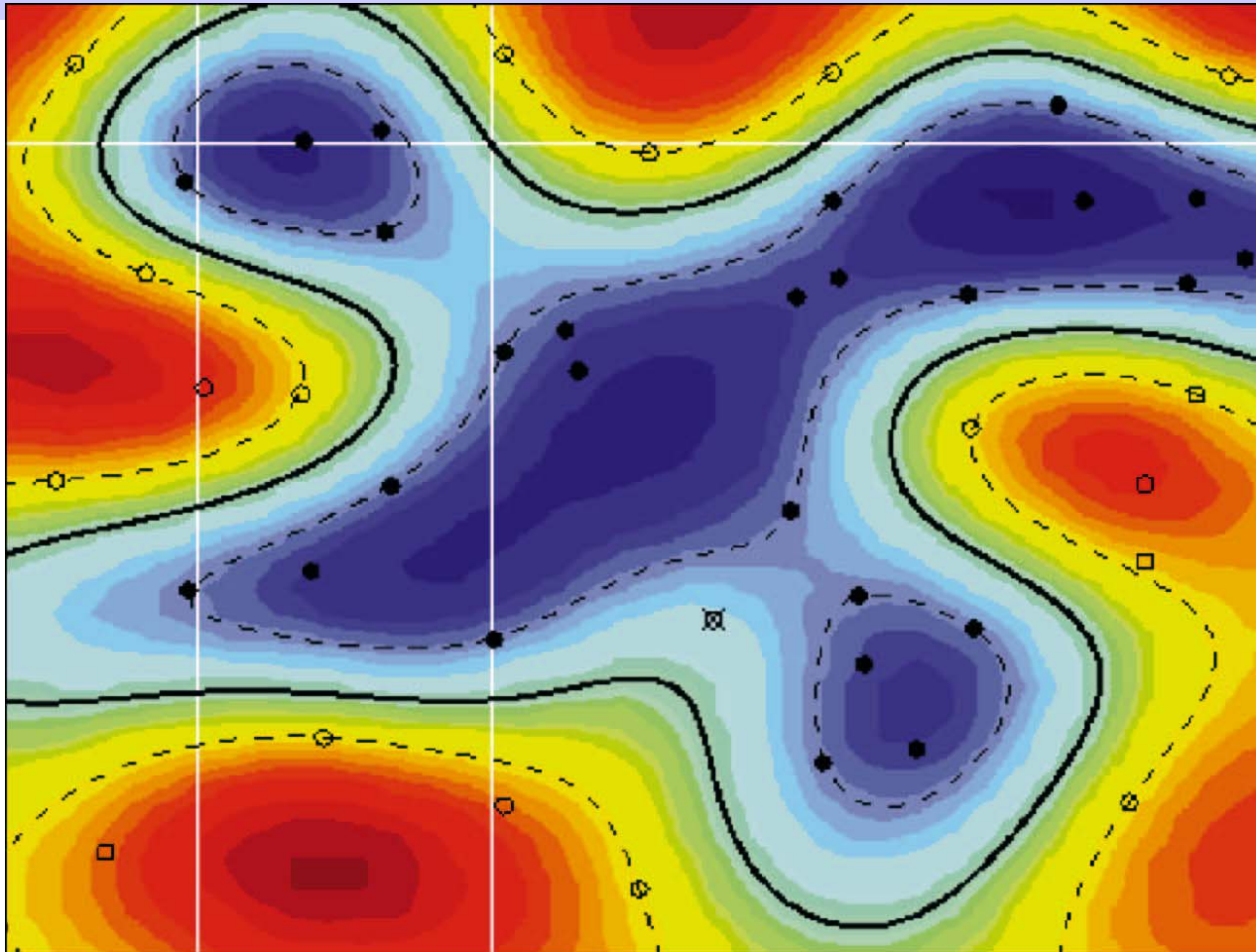

SVM Ingredients

- Support Vectors
- Mapping from Input Space to Feature Space
- Dot Product – Kernel function
- Weights

Classification of 2-D (Separable) data

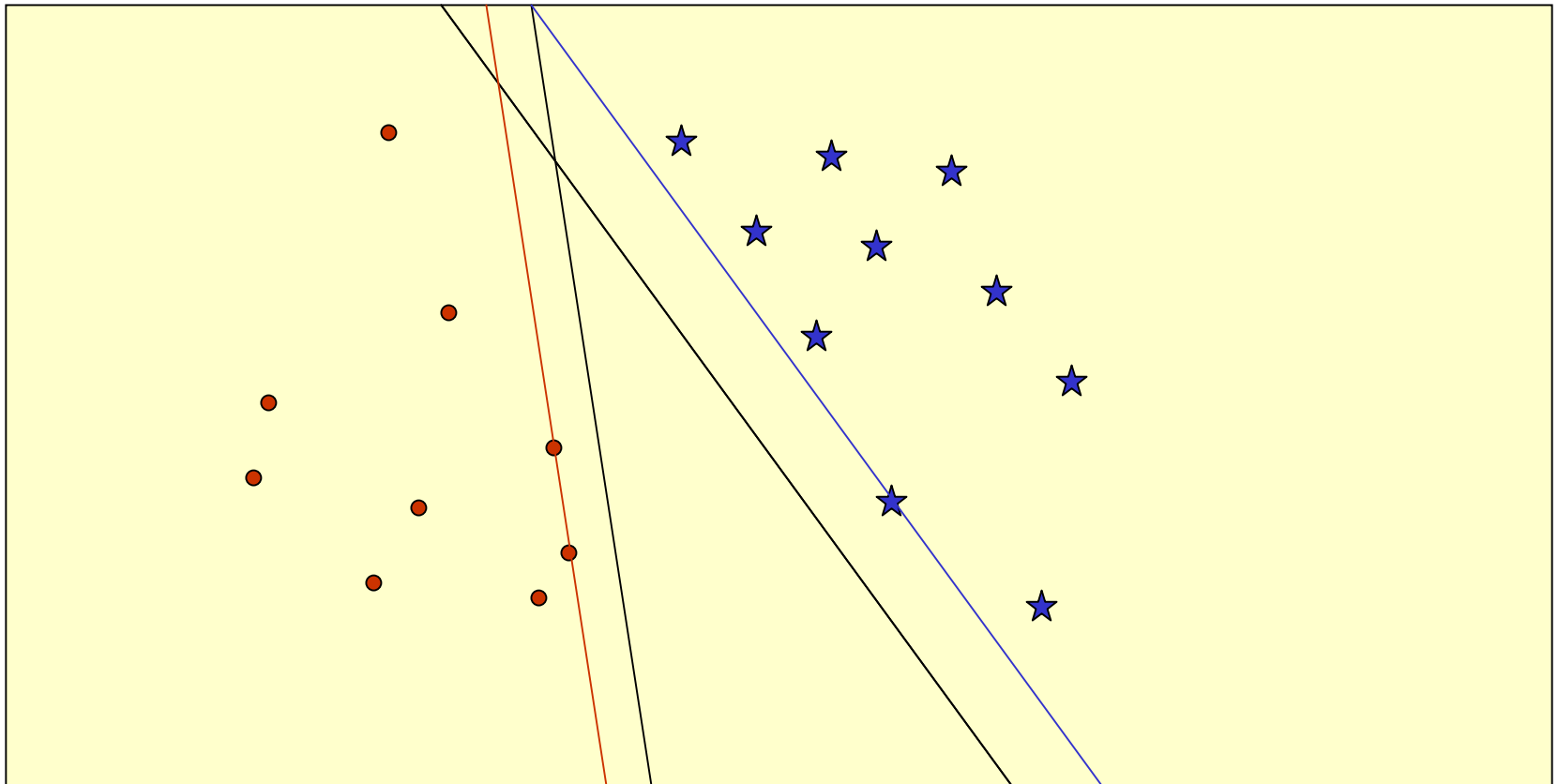

Classification of (Separable) 2-D data

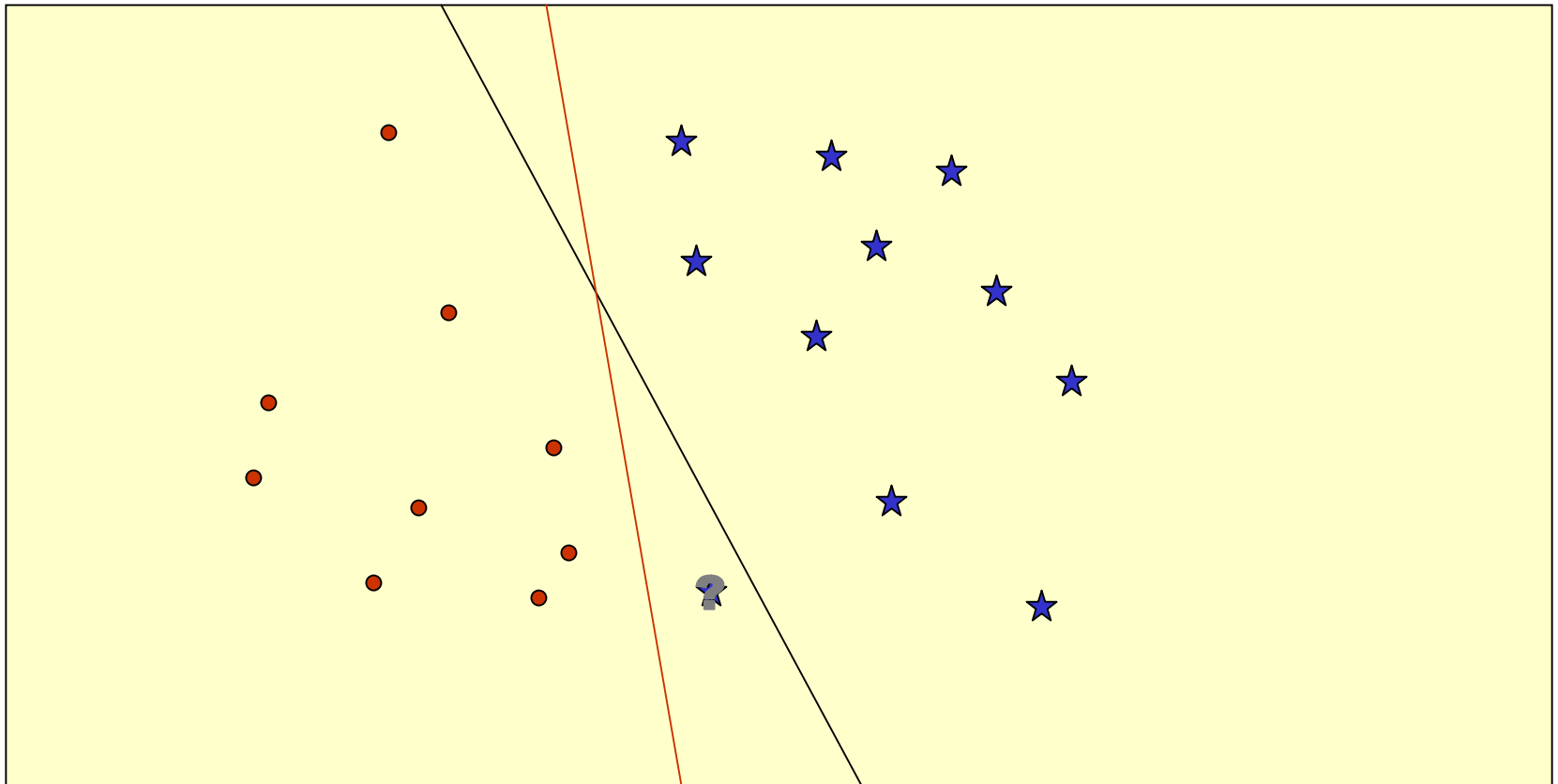

Classification of (Separable) 2-D data

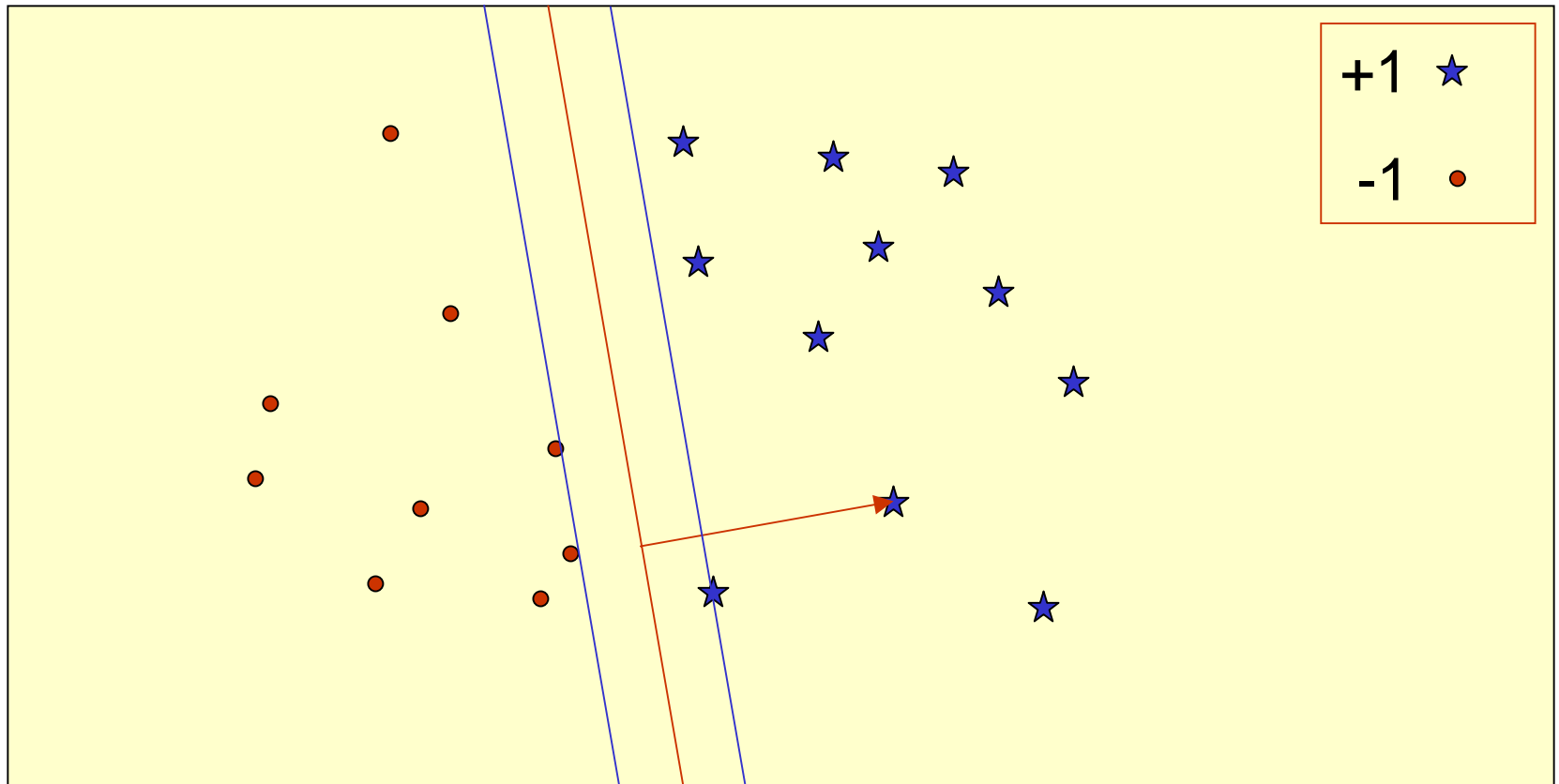

- Margin of a point
- Margin of a point set

Classification using the Separator

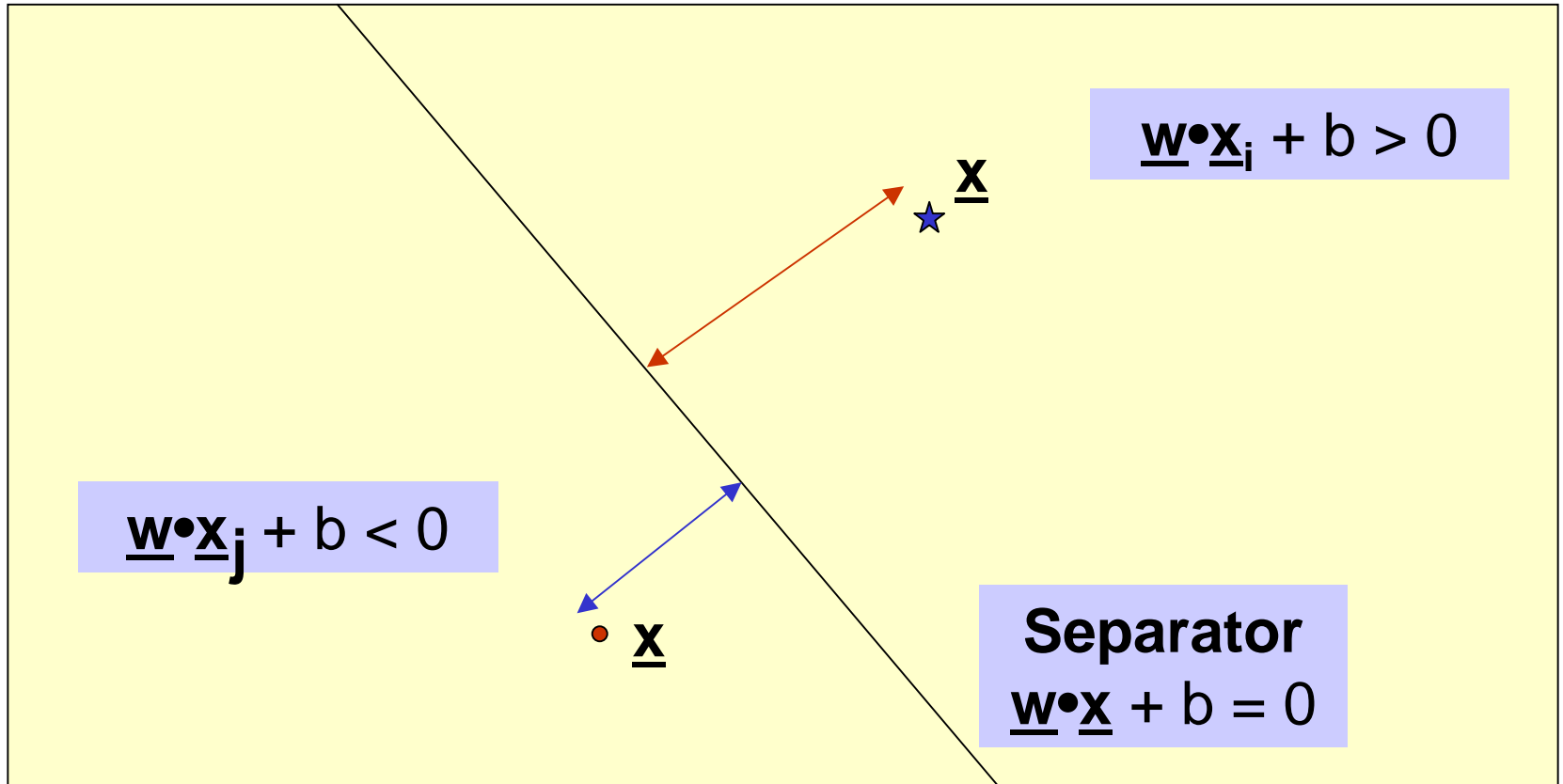

Perceptron Algorithm (Primal)

Rosenblatt, 1956

Given separable training set S and learning rate $\eta > 0$

$\underline{\mathbf{w}}_0 = \underline{\mathbf{0}}$; // Weight

$b_0 = 0$; // Bias

$k = 0$; $R = \max \|\underline{\mathbf{x}}_i\|$

repeat

for $i = 1$ to N

if $y_i (\underline{\mathbf{w}}_k \bullet \underline{\mathbf{x}}_i + b_k) \leq 0$ **then**

$\underline{\mathbf{w}}_{k+1} = \underline{\mathbf{w}}_k + \eta y_i \underline{\mathbf{x}}_i$

$b_{k+1} = b_k + \eta y_i R^2$

$k = k + 1$

Until no mistakes made within loop

Return k , and $(\underline{\mathbf{w}}_k, b_k)$ where $k = \#$ of mistakes

$$\underline{\mathbf{w}} = \sum a_i y_i \underline{\mathbf{x}}_i$$

Performance for Separable Data

Theorem:

If **margin** m of S is positive, then

$$k \leq (2R/m)^2$$

i.e., the algorithm will always converge,
and will converge quickly.

Perceptron Algorithm (Dual)

Given a separable training set S

$\underline{a} = \underline{0}$; $b_0 = 0$;

$R = \max \|\underline{x}_i\|$

repeat

for $i = 1$ to N

if $y_i (\sum a_j y_j \underline{x}_i \bullet \underline{x}_j + b) \leq 0$ **then**

$a_i = a_i + 1$

$b = b + y_i R^2$

Until no mistakes made within loop

Return (\underline{a}, b)

Non-linear Separators

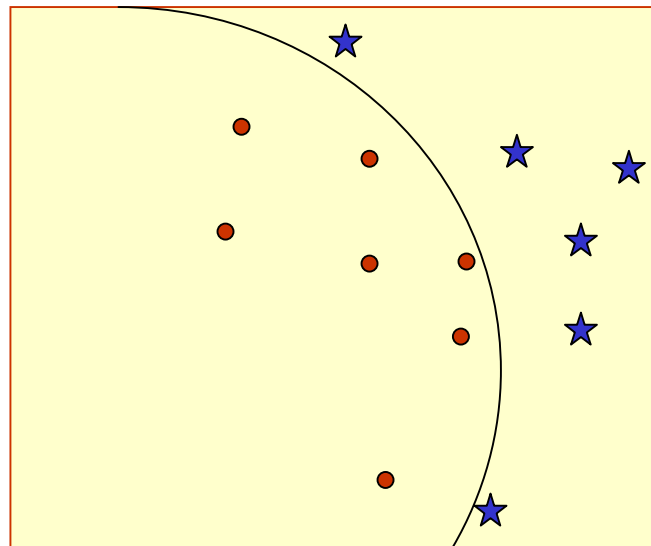

Main idea: Map into feature space

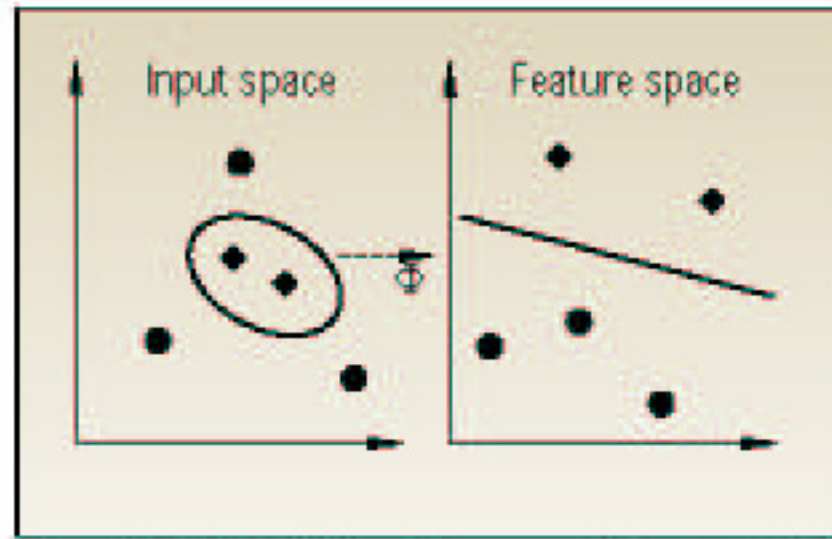
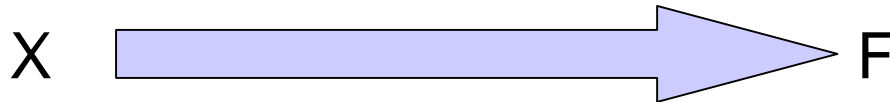
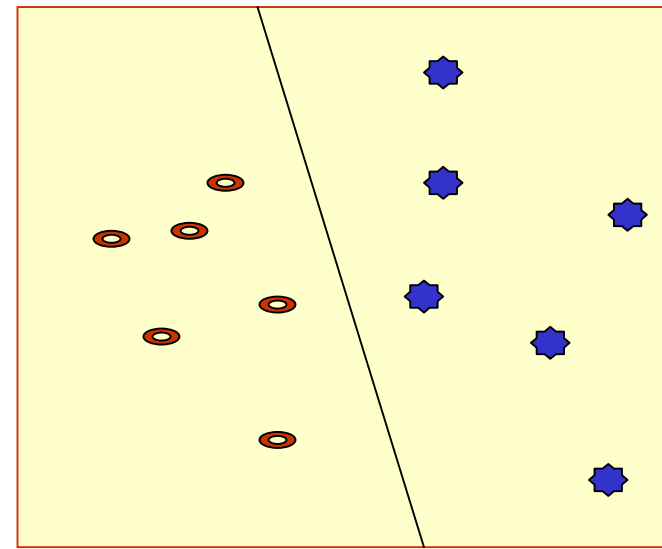
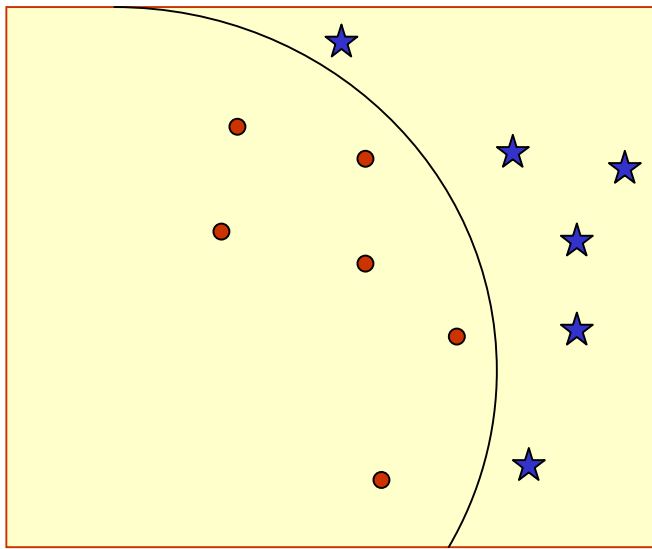

Figure 2. The idea of SVM machines: map the training data nonlinearly into a higher-dimensional feature space via Φ , and construct a separating hyperplane with maximum margin there. This yields a nonlinear decision boundary in input space. By the use of a kernel function, it is possible to compute the separating hyperplane without explicitly carrying out the map into the feature space.

Non-linear Separators



Useful URLs

- <http://www.support-vector.net>

Perceptron Algorithm (Dual)

Given a separable training set S

$\underline{a} = \underline{0}$; $b_0 = 0$;

$R = \max \|\underline{x}_i\|$

repeat

for $i = 1$ to N

if $y_i (\sum a_j y_j \kappa(\underline{x}_i, \underline{x}_j) + b) \leq 0$ **then**

$a_i = a_i + 1$

$b = b + y_i R^2$

Until no mistakes made within loop

Return (\underline{a}, b)

$$\kappa(\underline{x}_i, \underline{x}_j) = \Phi(\underline{x}_i) \cdot \Phi(\underline{x}_j)$$

Different Kernel Functions

- **Polynomial kernel** $\kappa(X, Y) = (X \bullet Y)^d$
- **Radial Basis Kernel** $\kappa(X, Y) = \exp\left(\frac{-\|X - Y\|^2}{2\sigma^2}\right)$
- **Sigmoid Kernel** $\kappa(X, Y) = \tanh(\omega(X \bullet Y) + \theta)$

SVM Ingredients

- Support Vectors
- Mapping from Input Space to Feature Space
- Dot Product – Kernel function

Generalizations

- How to deal with **more than 2 classes**?
Idea: Associate weight and bias for each class.
- How to deal with **non-linear separator**?
Idea: Support Vector Machines.
- How to deal with **linear regression**?
- How to deal with **non-separable data**?

Applications

- Text Categorization & Information Filtering
 - 12,902 Reuters Stories, 118 categories (91% !!)
- Image Recognition
 - Face Detection, tumor anomalies, defective parts in assembly line, etc.
- Gene Expression Analysis
- Protein Homology Detection

Class	Method	Learned threshold					Optimized threshold				
		FP	FN	TP	TN	Cost	FP	FN	TP	TN	Cost
Tricarboxylic acid	Radial SVM	8	8	9	2442	24	4	7	10	2446	18
	Dot-product-1 SVM	11	9	8	2439	29	3	6	11	2447	15
	Dot-product-2 SVM	5	10	7	2445	25	4	6	11	2446	16
	Dot-product-3 SVM	4	12	5	2446	28	4	6	11	2446	16
	Parzen	4	12	5	2446	28	0	12	5	2450	24
	FLD	9	10	7	2441	29	7	8	9	2443	23
	C4.5	7	17	0	2443	41	-	-	-	-	-
	MOC1	3	16	1	2446	35	-	-	-	-	-
Respiration	Radial SVM	9	6	24	2428	21	8	4	26	2429	16
	Dot-product-1 SVM	21	10	20	2416	41	6	9	21	2431	24
	Dot-product-2 SVM	7	14	16	2430	35	7	6	24	2430	19
	Dot-product-3 SVM	3	15	15	2434	33	7	6	24	2430	19
	Parzen	22	10	20	2415	42	7	12	18	2430	31
	FLD	10	10	20	2427	30	14	4	26	2423	22
	C4.5	18	17	13	2419	52	-	-	-	-	-
	MOC1	12	26	4	2425	64	-	-	-	-	-
Ribosome	Radial SVM	9	4	117	2337	17	6	1	120	2340	8
	Dot-product-1 SVM	13	6	115	2333	25	11	1	120	2335	13
	Dot-product-2 SVM	7	10	111	2339	27	9	1	120	2337	11
	Dot-product-3 SVM	3	18	103	2343	39	7	1	120	2339	9
	Parzen	6	8	113	2340	22	5	8	113	2341	21
	FLD	15	5	116	2331	25	8	3	118	2338	14
	C4.5	31	21	100	2315	73	-	-	-	-	-
	MOC1	26	26	95	2320	78	-	-	-	-	-

Table 2: Comparison of error rates for various classification methods. Classes are as described in Table 1. The methods are the radial basis function SVM, the SVMs using the scaled dot product kernel raised to the first, second and third power, Parzen windows, Fisher's linear discriminant, and the two decision tree learners, C4.5 and MOC1. The next five columns are the false positive, false negative, true positive and true negative rates summed over three cross-validation splits, followed by the cost, which is the number of false positives plus twice the number of false negatives. These five columns are repeated twice, first using the threshold learned from the training set, and then using the threshold that minimizes the cost on the test set. The threshold optimization is not possible for the decision tree methods, since they do not produce ranked results.

Class	Method	Learned threshold					Optimized threshold				
		FP	FN	TP	TN	Cost	FP	FN	TP	TN	Cost
Proteasome	Radial SVM	3	7	28	2429	17	4	5	30	2428	14
	Dot-product-1 SVM	14	11	24	2418	36	2	7	28	2430	16
	Dot-product-2 SVM	4	13	22	2428	30	4	6	29	2428	16
	Dot-product-3 SVM	3	18	17	2429	39	2	7	28	2430	16
	Parzen	21	5	30	2411	31	3	9	26	2429	21
	FLD	7	12	23	2425	31	12	7	28	2420	26
	C4.5	17	10	25	2415	37	-	-	-	-	-
	MOC1	10	17	18	2422	44	-	-	-	-	-
Histone	Radial SVM	0	2	9	2456	4	0	2	9	2456	4
	Dot-product-1 SVM	0	4	7	2456	8	0	2	9	2456	4
	Dot-product-2 SVM	0	5	6	2456	10	0	2	9	2456	4
	Dot-product-3 SVM	0	8	3	2456	16	0	2	9	2456	4
	Parzen	2	3	8	2454	8	1	3	8	2455	7
	FLD	0	3	8	2456	6	2	1	10	2454	4
	C4.5	2	2	9	2454	6	-	-	-	-	-
	MOC1	2	5	6	2454	12	-	-	-	-	-
Helix-turn-helix	Radial SVM	1	16	0	2450	33	0	16	0	2451	32
	Dot-product-1 SVM	20	16	0	2431	52	0	16	0	2451	32
	Dot-product-2 SVM	4	16	0	2447	36	0	16	0	2451	32
	Dot-product-3 SVM	1	16	0	2450	33	0	16	0	2451	32
	Parzen	14	16	0	2437	46	0	16	0	2451	32
	FLD	14	16	0	2437	46	0	16	0	2451	32
	C4.5	2	16	0	2449	34	-	-	-	-	-
	MOC1	6	16	0	2445	38	-	-	-	-	-

Table 3: Comparison of error rates for various classification methods (continued). See caption for Table 2.

Class	Kernel	Cost for each split					Total
Tricarboxylic acid	Radial	18	21	15	22	21	97
	Dot-product-1	15	22	18	23	22	100
	Dot-product-2	16	22	17	22	22	99
	Dot-product-3	16	22	17	23	22	100
Respiration	Radial	16	18	23	20	16	93
	Dot-product-1	24	24	29	27	23	127
	Dot-product-2	19	19	26	24	23	111
	Dot-product-3	19	19	26	22	21	107
Ribosome	Radial	8	12	15	11	13	59
	Dot-product-1	13	18	14	16	16	77
	Dot-product-2	11	16	14	16	15	72
	Dot-product-3	9	15	11	15	15	65
Proteasome	Radial	14	10	9	11	11	55
	Dot-product-1	16	12	12	17	19	76
	Dot-product-2	16	13	15	17	17	78
	Dot-product-3	16	13	16	16	17	79
Histone	Radial	4	4	4	4	4	20
	Dot-product-1	4	4	4	4	4	20
	Dot-product-2	4	4	4	4	4	20
	Dot-product-3	4	4	4	4	4	20

Table 4: Comparison of SVM performance using various kernels. For each of the MYGD classifications, SVMs were trained using four different kernel functions on five different random three-fold splits of the data, training on two-thirds and testing on the remaining third. The first column contains the class, as described in Table 1. The second column contains the kernel function, as described in Table 2. The next five columns contain the threshold-optimized cost (i.e., the number of false positives plus twice the number of false negatives) for each of the five random three-fold splits. The final column is the total cost across all five splits.

Family	Gene	Locus	Error	Description
TCA	YPR001W	CIT3	FN	mitochondrial citrate synthase
	YOR142W	LSC1	FN	α subunit of succinyl-CoA ligase
	YNR001C	CIT1	FN	mitochondrial citrate synthase
	YLR174W	IDP2	FN	isocitrate dehydrogenase
	YIL125W	KGD1	FN	α -ketoglutarate dehydrogenase
	YDR148C	KGD2	FN	component of α -ketoglutarate dehydrogenase complex in mitochondria
	YDL066W	IDP1	FN	mitochondrial form of isocitrate dehydrogenase
	YBL015W	ACH1	FP	acetyl CoA hydrolase
Resp	YPR191W	QCR2	FN	ubiquinol cytochrome-c reductase core protein 2
	YPL271W	ATP15	FN	ATP synthase epsilon subunit
	YPL262W	FUM1	FP	fumarase
	YML120C	ND1	FP	mitochondrial NADH ubiquinone 6 oxidoreductase
	YKL085W	MDH1	FP	mitochondrial malate dehydrogenase
	YDL067C	COX9	FN	subunit VIIa of cytochrome c oxidase
Ribo	YPL037C	EGD1	FP	β subunit of the nascent-polypeptide-associated complex (NAC)
	YLR406C	RPL31B	FN	ribosomal protein L31B (L34B) (YL28)
	YLR075W	RPL10	FP	ribosomal protein L10
	YAL003W	EFB1	FP	translation elongation factor EF-1 β
Prot	YHR027C	RPN1	FN	subunit of 26S proteasome (PA700 subunit)
	YGR270W	YTA7	FN	member of CDC48/PAS1/SEC18 family of ATPases
	YGR048W	UFD1	FP	ubiquitin fusion degradation protein
	YDR069C	DOA4	FN	ubiquitin isopeptidase
	YDL020C	RPN4	FN	involved in ubiquitin degradation pathway
Hist	YOL012C	HTA3	FN	histone-related protein
	YKL049C	CSE4	FN	required for proper kinetochore function

Table 6: Consistently misclassified genes. The table lists all 25 genes that are consistently misclassified by SVMs trained using the MYGD classifications listed in Table 1. Two types of errors are included: a false positive (FP) occurs when the SVM includes the gene in the given class but the MYGD classification does not; a false negative (FN) occurs when the SVM does not include the gene in the given class but the MYGD classification does.

Kernel	DF	Feature	FP	FN	TP	TN
dot-product 0		25	5	4	10	12
dot-product 2		25	5	2	12	12
dot-product 5		25	4	2	12	13
dot-product 10		25	4	2	12	13
dot-product 0		50	4	2	12	13
dot-product 2		50	3	2	12	14
dot-product 5		50	3	2	12	14
dot-product 10		50	3	2	12	14
dot-product 0		100	4	3	11	13
dot-product 2		100	5	3	11	12
dot-product 5		100	5	3	11	12
dot-product 10		100	5	3	11	12
dot-product 0		500	5	3	11	12
dot-product 2		500	4	3	11	13
dot-product 5		500	4	3	11	13
dot-product 10		500	4	3	11	13
dot-product 0		1000	7	3	11	10
dot-product 2		1000	5	3	11	12
dot-product 5		1000	5	3	11	12
dot-product 10		1000	5	3	11	12
dot-product 0		97802	17	0	14	0
dot-product 2		97802	9	2	12	8
dot-product 5		97802	7	3	11	10
dot-product 10		97802	5	3	11	12

Table 1: Error rates for ovarian cancer tissue experiments.

For each setting of the SVM consisting of a kernel and diagonal factor (DF), each tissue was classified. Column 2 is the number of features (clones) used. Reported are the number of normal tissues misclassified (FP), tumor tissues misclassified (FN), tumor tissues classified correctly (TP), and normal tissues classified correctly (TN).

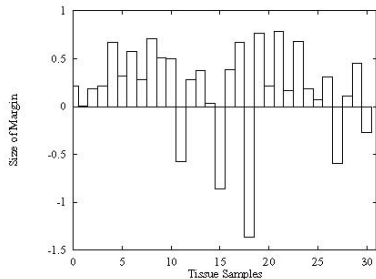
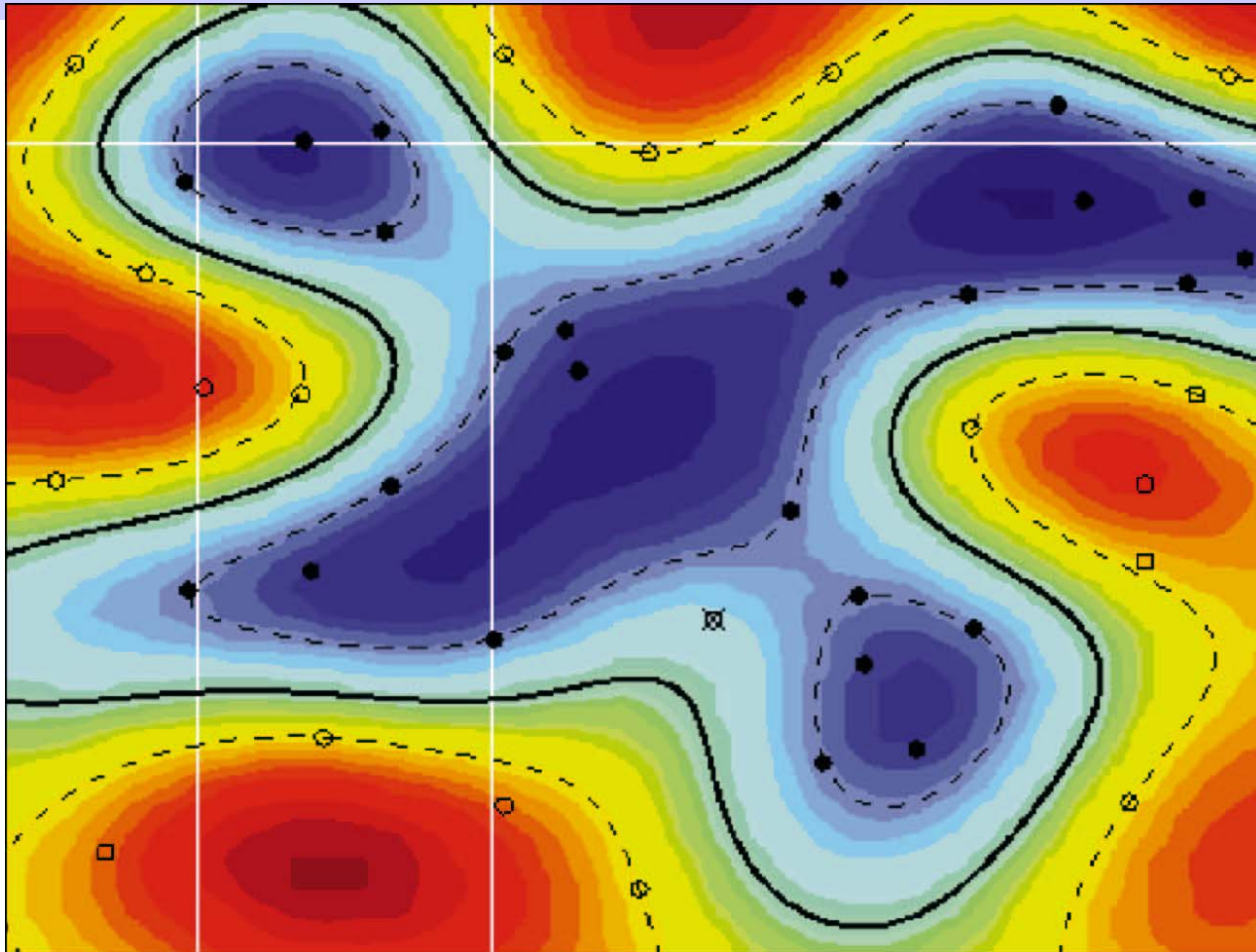

Figure 1: SVM classification margins for ovarian tissues. When classifying, the SVM calculates a margin which is the distance of an example from the decision boundary it has learned. In this graph, the margin for each tissue sample calculated using (10) is shown. A positive value indicates a correct classification, and a negative value indicates an incorrect classification. The most negative point corresponds to tissue N039. The second most negative point corresponds to tissue HWBC3.

Dataset	Features	FP	FN	SVM FP	SVM FN
Ovarian(original)	97802	4.6	4.8	5	3
Ovarian(modified)	97802	4.4	3.4	0	0
AML/ALL train	7129	0.6	2.8	0	0
AML treatment	7129	4.8	3.5	3	2
Colon	2000	3.8	3.7	3	3

Table 5: Results for the perceptron on all data sets. The results are averaged over 5 shufflings of the data as this algorithm is sensitive to the order in which it receives the data points. The first column is the dataset used and the second is number of features in the dataset. For the ovarian and colon datasets, the number of normal tissues misclassified (FP) and the number of tumor tissues misclassified (FN) is reported. For the AML/ALL training dataset, the number of AML samples misclassified (FP) and the number of ALL patients misclassified (FN) is reported. For the AML treatment dataset, the number of unsuccessfully treated patients misclassified (FP) and the number of successfully treated patients misclassified (FN) is reported. The last two columns report the best score obtained by the SVM on that dataset.

SVM Example (Radial Basis Function)



Sources of Variations & Errors in Microarray Data

- Variations in cells/individuals.
- Variations in mRNA extraction, isolation, introduction of dye, variation in dye incorporation, dye interference.
- Variations in probe concentration, probe amounts, substrate surface characteristics
- Variations in hybridization conditions and kinetics
- Variations in optical measurements, spot misalignments, discretization effects, noise due to scanner lens and laser irregularities
- Cross-hybridization of sequences with high sequence identity.
- Limit of factor 2 in precision of results.

Need to Normalize data

Significance Analysis of Microarrays (SAM) [Tusher, Tibshirani, Chu, PNAS'01]

- Fold change is a typical measure to decide genes of interest.
- However, variations in gene expression are also gene dependent. If **repeats are available**, then such variations can be measured for each gene. This helps to give a better analysis of significant genes of interest.

Genomics

- Study of all genes in a genome, or comparison of whole genomes.
 - Whole genome sequencing
 - Whole genome annotation & Functional genomics
 - Whole genome comparison
 - **PipMaker**: uses BLASTZ to compare very long sequences (> 2Mb); <http://www.cse.psu.edu/pipmaker/>
 - **Mummer**: used for comparing long microbial sequences (uses Suffix trees!)

Genomics (Cont'd)

– Gene Expression

- Microarray experiments & analysis
 - Probe design (**CODEHOP**)
 - Array image analysis (**CrazyQuant**)
 - Identifying genes with significant changes (**SAM**)
 - Clustering

Proteomics

- Study of all **proteins** in a genome, or comparison of whole genomes.
 - Whole genome annotation & Functional proteomics
 - Whole genome comparison
 - Protein Expression: **2D Gel Electrophoresis**

2D Gel Electrophoresis

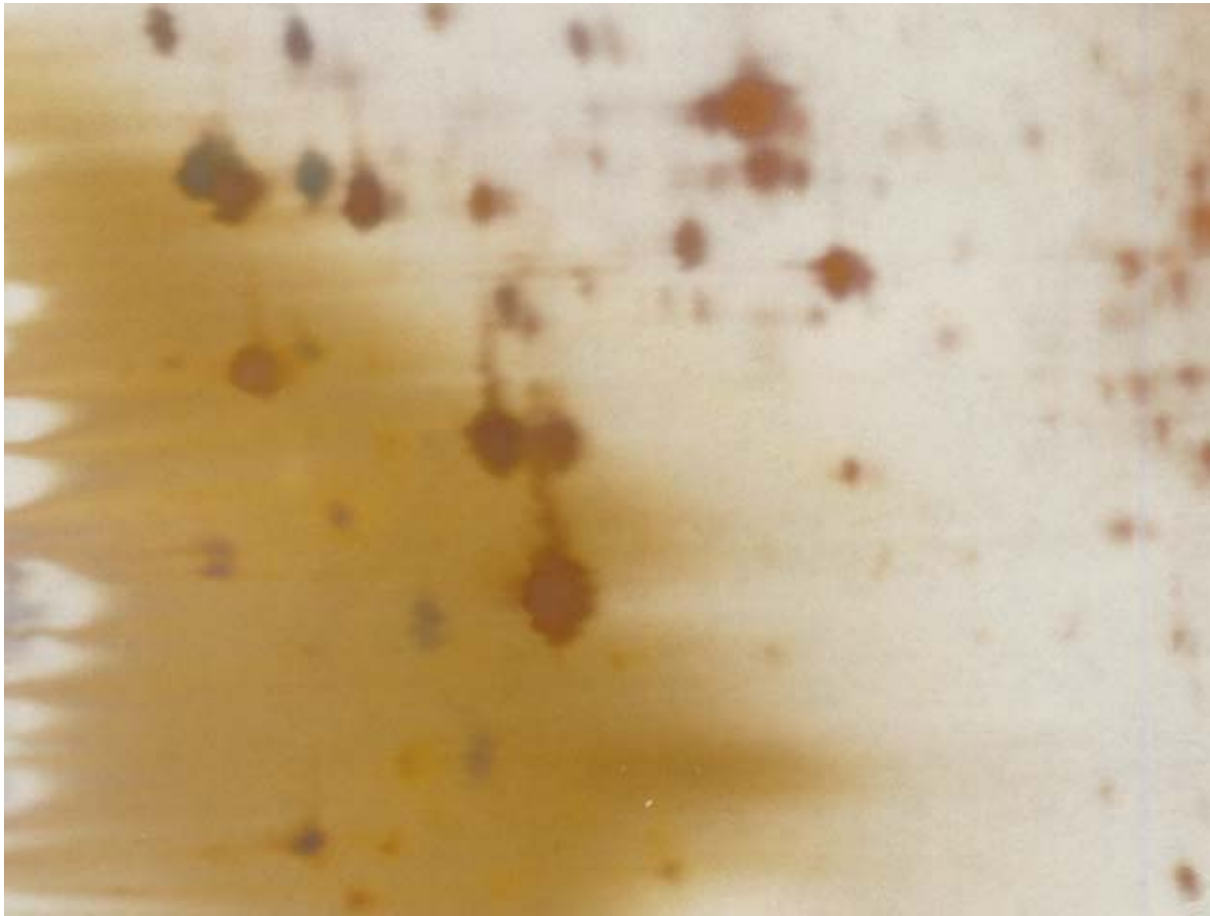

Other Proteomics Tools

From ExPASy/SWISS-PROT:

- **AACompIdent** identify proteins from aa composition
[Input: aa composition, isoelectric point, mol wt., etc. Output: proteins from DB]
- **AACompSim** compares proteins aa composition with other proteins
- **MultIdent** uses mol wt., mass fingerprints, etc. to identify proteins
- **PeptIdent** compares experimentally determined mass fingerprints with theoretically determined ones for all proteins
- **FindMod** predicts post-translational modifications based on mass difference between experimental and theoretical mass fingerprints.
- **PeptideMass** theoretical mass fingerprint for a given protein.
- **GlycoMod** predicts oligosaccharide modifications from mass difference
- **TGREASE** calculates hydrophobicity of protein along its length

Databases for Comparative Genomics

- PEDANT useful resource for standard questions in comparative genomics. For e.g., *how many known proteins in XXX have known 3-d structures, how many proteins from family YYY are in ZZZ, etc.*
- COGs Clusters of orthologous groups of proteins.
- MBGD Microbial genome database searches for homologs in all microbial genomes

Gene Networks & Pathways

- Genes & Proteins act in concert and therefore form a complex network of dependencies.

Pathway Example from KEGG

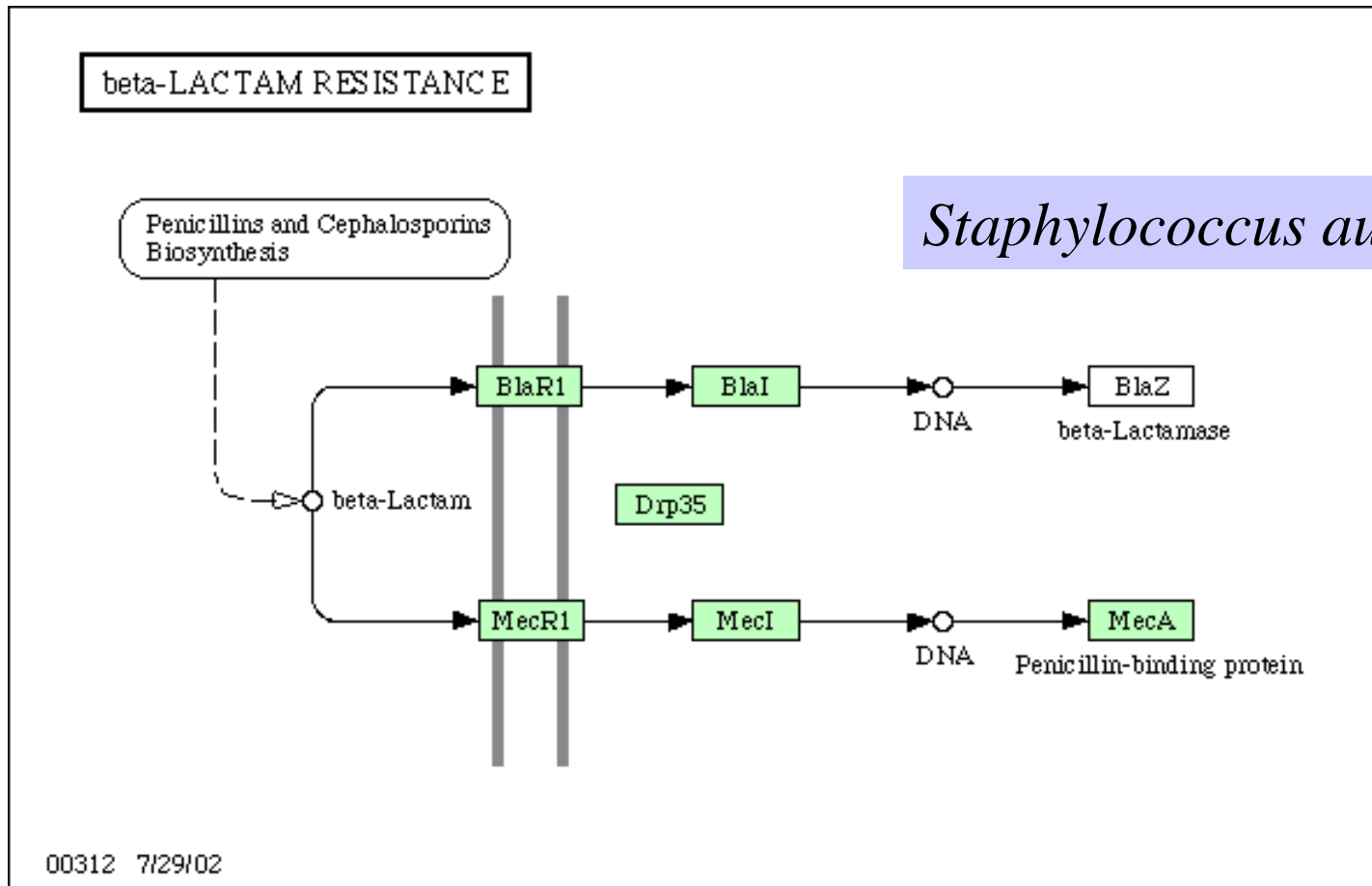

Pseudomonas aeruginosa

METHIONINE METABOLISM

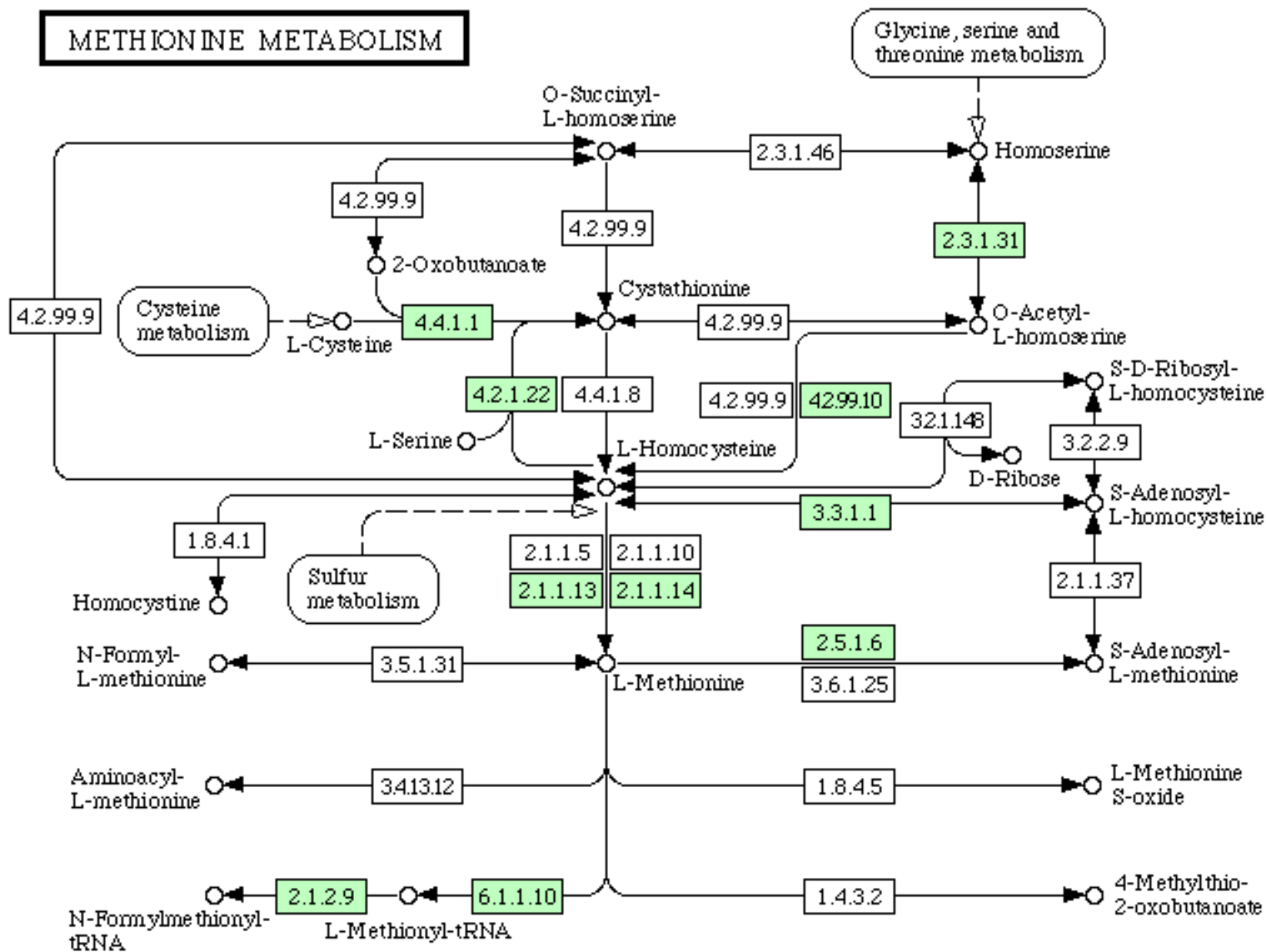

STSs and ESTs

- **Sequence-Tagged Site**: short, unique sequence
- **Expressed Sequence Tag**: short, unique sequence from a coding region
 - 1991: 609 ESTs [Adams et al.]
 - June 2000: 4.6 million in **dbEST**
 - Genome sequencing center at St. Louis produce 20,000 ESTs per week.

What Are ESTs and How Are They Made?

- Small pieces of DNA sequence (usually 200 - 500 nucleotides) of low quality.
- Extract mRNA from cells, tissues, or organs and sequence either end. Reverse transcribe to get cDNA (5' EST and 3'EST) and deposit in EST library.
- Used as "**tags**" or markers for that gene.
- Can be used to identify similar genes from other organisms (Complications: variations among organisms, variations in genome size, presence or absence of **introns**).
- 5' ESTs tend to be more useful (cross-species conservation), 3' EST often in UTR.

DNA Markers

- Uniquely identifiable DNA segments.
- Short, <500 nucleotides.
- Layout of these markers give a **map** of genome.
- Markers may be **polymorphic** (variations among individuals). Polymorphism gives rise to **alleles**.
- Found by PCR assays.

Polymorphisms

- Length polymorphisms
 - Variable # of tandem repeats (VNTR)
 - Microsatellites or short tandem repeats
 - Restriction fragment length polymorphism (RFLP) caused by changes in restriction sites.
- Single nucleotide polymorphism (SNP)
 - Average once every ~100 bases in humans
 - Usually biallelic
 - **dbSNP** database of SNPs (over 100,000 SNPs)
 - ESTs are a good source of SNPs

SNPs

- SNPs often act as “disease markers”, and provide “genetic predisposition”.
- SNPs may explain differences in drug response of individuals.
- **Association study**: study SNP patterns in diseased individuals and compare against SNP patterns in normal individuals.
- Many diseases associated with SNP profile.